

# flash®

Güven elinizin altında

Fiyat Listesi  
2024



[www.flashelektrik.com](http://www.flashelektrik.com)



2

3 kA-1P-3P  
Otomatik Sigortalar



3

3 kA-2P-4P  
Otomatik Sigortalar



4

6 kA-1P-3P  
Otomatik Sigortalar



5

6 kA-2P-4P  
Otomatik Sigortalar



6

10 kA-1P-3P  
Otomatik Sigortalar



7

10 kA-2P-4P  
Otomatik Sigortalar



8

Mekanik Kaçak Akım Koruma  
Şalterleri 2P-4P 10 kA



9

Mekanik Kaçak Akım Koruma  
Şalterleri 2P-4P 6 kA



11

Güç Kontaktörleri (FLTC)



11

Termik Röleler (FTR1)



11

Kontaktör Yardımcı Kontak  
Blokları (FYK)



12

Güç Kontaktörleri (FLKC)



12

Termik Röleler (FTR3),  
Modüler Kontaktörler (FLMC)



13

Güç Kontaktörleri (FLSC)



13

Termik Röleler (FTR2)



14

4 Kutuplu Güç Kontaktörleri  
(FLTC4)



14

Mini Güç Kontaktörleri  
(FLTC-M)



14

Mini Termik Röleler  
(FTR3 -M)



16

4 Kutuplu Kaçak Akım Algılamalı  
Yangın Korumalı (Sabit) Termik  
Manyetik Kompakt Şalterler (FHL)



16

4 Kutuplu Kaçak Akım Algılamalı  
Yangın Korumalı (Ayar Sahalı) Termik  
Manyetik Kompakt Şalterler (FHL)



17

3P ve 4P Termik Manyetik  
Kompakt Şalterler (FHD) Sabit



18

3P ve 4P Termik Manyetik  
Kompakt Şalterler (FHQ) Ayarlı



19

Darbe Akım Anahtarı (FDA)  
Sinyal ve Alarm Kontaklı (YKB),  
Düşük Gerilim Bobini (DGB)  
Pano Prizi (FPP)



20

Kaçak Akım Algılama Rölesi  
(KAR)



20

Toroidal Akım Transformörü  
(TAT), Açırma Bobini (FAB)



21

Motor Koruma Şalteri (FMK)



21

Analog Günlük Zaman Saati  
(FZR100), Priz Modelli Zaman  
Saati (FPZ)



22

Kablo Papuçları (FKP), Uzatma  
Barası (UZB), Ray Tipi Toprak



24

Ölçü Cihazları (Voltmetre,  
Ampermetre)



25-28

Sinyal Lambaları - Butonlar -  
Anahtarlar



Örüne özel  
barkod



İade garantisi



Lojistik destek

- ✓ Bu fiyat listesi 01.06.2024 tarihi itibarı ile vereceğiniz siparişler için geçerlidir.
- ✓ Liste fiyatlarına K.D.V. dahil değildir.
- ✓ Siparişler koli bazında kargo ile teslim edilecektir.
- ✓ İhale ve proje alımları Flash'ın düzenleyebileceği kampanyalara dahil edilemez.

- ✓ Tüm ürünlerimiz imalat hatalarına karşı 3 & 5 yıl boyunca firmamız garantisi altındadır.
- ✓ Bu listedeki fotoğraflar temsildir. Gerçek ürünler fotoğraflardan farklılık gösterebilir.
- ✓ Bu fiyat listesindeki baskı hatalarından firmamız sorumlu tutulamaz.
- ✓ Fiyatlarımızda önceden herhangi bir uyarıya gerek duyulmaksızın değişiklik yapma hakkımız saklıdır.



## Otomatik Sigortalar ve Kaçak Şalterleri



## 1 Kutuplu Otomatik Sigortalar (C ve B Tipi)

Sipariş Kodu <b>C</b> Eğrisi için	Sipariş Kodu <b>B</b> Eğrisi için	Anma Akımı (A)	Kutu / Koli (Adet)	Birim Fiyatı (TL)
FMC-1-02/3kA	FMB-1-02/3kA	2A	10 / 200	133,00
FMC-1-03/3kA	FMB-1-03/3kA	3A	10 / 200	133,00
FMC-1-04/3kA	FMB-1-04/3kA	4A	10 / 200	133,00
FMC-1-06/3kA	FMB-1-06/3kA	6A	10 / 200	105,00
FMC-1-10/3kA	FMB-1-10/3kA	10A	10 / 200	105,00
FMC-1-16/3kA	FMB-1-16/3kA	16A	10 / 200	105,00
FMC-1-20/3kA	FMB-1-20/3kA	20A	10 / 200	105,00
FMC-1-25/3kA	FMB-1-25/3kA	25A	10 / 200	105,00
FMC-1-32/3kA	FMB-1-32/3kA	32A	10 / 200	120,00
FMC-1-40/3kA	FMB-1-40/3kA	40A	10 / 200	125,00
FMC-1-50/3kA	FMB-1-50/3kA	50A	10 / 200	140,00
FMC-1-63/3kA	FMB-1-63/3kA	63A	10 / 200	145,00

3 kA



TS 5018-1 EN 60898-1  
ISO 9001:2000



## 3 Kutuplu Otomatik Sigortalar (C ve B Tipi)

Sipariş Kodu <b>C</b> Eğrisi için	Sipariş Kodu <b>B</b> Eğrisi için	Anma Akımı (A)	Kutu / Koli (Adet)	Birim Fiyatı (TL)
FMC-3-06/3kA	FMB-3-06/3kA	6A	4 / 80	355,00
FMC-3-10/3kA	FMB-3-10/3kA	10A	4 / 80	355,00
FMC-3-16/3kA	FMB-3-16/3kA	16A	4 / 80	355,00
FMC-3-20/3kA	FMB-3-20/3kA	20A	4 / 80	355,00
FMC-3-25/3kA	FMB-3-25/3kA	25A	4 / 80	355,00
FMC-3-32/3kA	FMB-3-32/3kA	32A	4 / 80	387,00
FMC-3-40/3kA	FMB-3-40/3kA	40A	4 / 80	400,00
FMC-3-50/3kA	FMB-3-50/3kA	50A	4 / 80	459,00
FMC-3-63/3kA	FMB-3-63/3kA	63A	4 / 80	474,00

3 kA



TS 5018-1 EN 60898-1  
ISO 9001:2000





## 2 Kutuplu Otomatik Sigortalar (C ve B Tipi)

Sipariş Kodu <b>C</b> Eğrisi için	Sipariş Kodu <b>B</b> Eğrisi için	Anma Akımı (A)	Kutu / Koli (Adet)	Birim Fiyatı (TL)
FMC-2-06/3kA	FMB-2-06/3kA	6A	6 / 120	240,00
FMC-2-10/3kA	FMB-2-10/3kA	10A	6 / 120	240,00
FMC-2-16/3kA	FMB-2-16/3kA	16A	6 / 120	240,00
FMC-2-20/3kA	FMB-2-20/3kA	20A	6 / 120	240,00
FMC-2-25/3kA	FMB-2-25/3kA	25A	6 / 120	240,00
FMC-2-32/3kA	FMB-2-32/3kA	32A	6 / 120	258,00
FMC-2-40/3kA	FMB-2-40/3kA	40A	6 / 120	267,00
FMC-2-50/3kA	FMB-2-50/3kA	50A	6 / 120	306,00
FMC-2-63/3kA	FMB-2-63/3kA	63A	6 / 120	316,00

3 kA



TS 5018-1 EN 60898-1  
ISO 9001:2000



## 4 Kutuplu Otomatik Sigortalar (C ve B Tipi)

Sipariş Kodu <b>C</b> Eğrisi için	Sipariş Kodu <b>B</b> Eğrisi için	Anma Akımı (A)	Kutu / Koli (Adet)	Birim Fiyatı (TL)
FMC-4-06/3kA	FMB-4-06/3kA	6A	3 / 60	490,00
FMC-4-10/3kA	FMB-4-10/3kA	10A	3 / 60	490,00
FMC-4-16/3kA	FMB-4-16/3kA	16A	3 / 60	490,00
FMC-4-20/3kA	FMB-4-20/3kA	20A	3 / 60	490,00
FMC-4-25/3kA	FMB-4-25/3kA	25A	3 / 60	490,00
FMC-4-32/3kA	FMB-4-32/3kA	32A	3 / 60	533,00
FMC-4-40/3kA	FMB-4-40/3kA	40A	3 / 60	551,00
FMC-4-50/3kA	FMB-4-50/3kA	50A	3 / 60	632,00
FMC-4-63/3kA	FMB-4-63/3kA	63A	3 / 60	652,00

3 kA



TS 5018-1 EN 60898-1  
ISO 9001:2000



## 1 Kutuplu Otomatik Sigortalar (C ve B Tipi)

6 kA

Sipariş Kodu <b>C</b> Eğrisi için	Sipariş Kodu <b>B</b> Eğrisi için	Anma Akımı (A)	Kutu / Koli (Adet)	Birim Fiyatı (TL)
FMC6-1-06/C	FMB6-1-06/B	6A	12 / 240	120,00
FMC6-1-10/C	FMB6-1-10/B	10A	12 / 240	120,00
FMC6-1-16/C	FMB6-1-16/B	16A	12 / 240	120,00
FMC6-1-20/C	FMB6-1-20/B	20A	12 / 240	120,00
FMC6-1-25/C	FMB6-1-25/B	25A	12 / 240	120,00
FMC6-1-32/C	FMB6-1-32/B	32A	12 / 240	137,00
FMC6-1-40/C	FMB6-1-40/B	40A	12 / 240	142,00
FMC6-1-50/C	FMB6-1-50/B	50A	12 / 240	160,00
FMC6-1-63/C	FMB6-1-63/B	63A	12 / 240	166,00



TS 5018-1 EN 60898-1  
ISO 9001:2000



## 3 Kutuplu Otomatik Sigortalar (C ve B Tipi)

6 kA

Sipariş Kodu <b>C</b> Eğrisi için	Sipariş Kodu <b>B</b> Eğrisi için	Anma Akımı (A)	Kutu / Koli (Adet)	Birim Fiyatı (TL)
FMC6-3-06/C	FMB6-3-06/B	6A	4 / 80	375,00
FMC6-3-10/C	FMB6-3-10/B	10A	4 / 80	375,00
FMC6-3-16/C	FMB6-3-16/B	16A	4 / 80	375,00
FMC6-3-20/C	FMB6-3-20/B	20A	4 / 80	375,00
FMC6-3-25/C	FMB6-3-25/B	25A	4 / 80	375,00
FMC6-3-32/C	FMB6-3-32/B	32A	4 / 80	428,00
FMC6-3-40/C	FMB6-3-40/B	40A	4 / 80	443,00
FMC6-3-50/C	FMB6-3-50/B	50A	4 / 80	513,00
FMC6-3-63/C	FMB6-3-63/B	63A	4 / 80	529,00



TS 5018-1 EN 60898-1  
ISO 9001:2000



## 2 Kutuplu Otomatik Sigortalar (C ve B Tipi)

6 kA

Sipariş Kodu C Eğrisi için	Sipariş Kodu B Eğrisi için	Anma Akımı (A)	Kutu / Koli (Adet)	Birim Fiyatı (TL)
FMC6-2-06/C	FMB6-2-06/B	6A	6 / 120	251,00
FMC6-2-10/C	FMB6-2-10/B	10A	6 / 120	251,00
FMC6-2-16/C	FMB6-2-16/B	16A	6 / 120	251,00
FMC6-2-20/C	FMB6-2-20/B	20A	6 / 120	251,00
FMC6-2-25/C	FMB6-2-25/B	25A	6 / 120	251,00
FMC6-2-32/C	FMB6-2-32/B	32A	6 / 120	295,00
FMC6-2-40/C	FMB6-2-40/B	40A	6 / 120	304,00
FMC6-2-50/C	FMB6-2-50/B	50A	6 / 120	353,00
FMC6-2-63/C	FMB6-2-63/B	63A	6 / 120	364,00

YERLİ  
ÜRETİM



TS 5018-1 EN 60898-1  
ISO 9001:2000



## 4 Kutuplu Otomatik Sigortalar (C ve B Tipi)

6 kA

Sipariş Kodu C Eğrisi için	Sipariş Kodu B Eğrisi için	Anma Akımı (A)	Kutu / Koli (Adet)	Birim Fiyatı (TL)
FMC6-4-06/C	FMB6-4-06/B	6A	3 / 60	534,00
FMC6-4-10/C	FMB6-4-10/B	10A	3 / 60	534,00
FMC6-4-16/C	FMB6-4-16/B	16A	3 / 60	534,00
FMC6-4-20/C	FMB6-4-20/B	20A	3 / 60	534,00
FMC6-4-25/C	FMB6-4-25/B	25A	3 / 60	534,00
FMC6-4-32/C	FMB6-4-32/B	32A	3 / 60	610,00
FMC6-4-40/C	FMB6-4-40/B	40A	3 / 60	628,00
FMC6-4-50/C	FMB6-4-50/B	50A	3 / 60	707,00
FMC6-4-63/C	FMB6-4-63/B	63A	3 / 60	727,00

YERLİ  
ÜRETİM



TS 5018-1 EN 60898-1  
ISO 9001:2000



## 1 Kutuplu Otomatik Sigortalar (B ve C Tipi)

Sipariş Kodu B/C Eğrisi için	Sipariş Kodu B/C Yerli Üretim	Anma Akımı (A)	Kutu / Koli (Adet)	Birim Fiyatı (TL)
HFN10-1-02	-	2A	10 / 200	180,00
HFN10-1-03	-	3A	10 / 200	180,00
HFN10-1-04	-	4A	10 / 200	180,00
HFN10-1-06	FMC10-1-06	6A	10 / 200	163,00
HFN10-1-10	FMC10-1-10	10A	10 / 200	163,00
HFN10-1-16	FMC10-1-16	16A	10 / 200	163,00
HFN10-1-20	FMC10-1-20	20A	10 / 200	163,00
HFN10-1-25	FMC10-1-25	25A	10 / 200	163,00
HFN10-1-32	FMC10-1-32	32A	10 / 200	173,00
HFN10-1-40	FMC10-1-40	40A	10 / 200	185,00
HFN10-1-50	FMC10-1-50	50A	10 / 200	193,00
HFN10-1-63	FMC10-1-63	63A	10 / 200	203,00
HFN10-1-80	-	80A	12 / 120	675,00
HFN10-1-100	-	100A	12 / 120	700,00
HFN10-1-125	-	125A	12 / 120	750,00

10 kA



TS 5018-1 EN 60898-1  
ISO 9001:2000



## 3 Kutuplu Otomatik Sigortalar (B ve C Tipi)

Sipariş Kodu B/C Eğrisi için	Sipariş Kodu B/C Yerli Üretim	Anma Akımı (A)	Kutu / Koli (Adet)	Birim Fiyatı (TL)
HFN10-3-06	FMC10-3-06	6A	4 / 80	521,00
HFN10-3-10	FMC10-3-10	10A	4 / 80	521,00
HFN10-3-16	FMC10-3-16	16A	4 / 80	521,00
HFN10-3-20	FMC10-3-20	20A	4 / 80	521,00
HFN10-3-25	FMC10-3-25	25A	4 / 80	521,00
HFN10-3-32	FMC10-3-32	32A	4 / 80	564,00
HFN10-3-40	FMC10-3-40	40A	4 / 80	580,00
HFN10-3-50	FMC10-3-50	50A	4 / 80	610,00
HFN10-3-63	FMC10-3-63	63A	4 / 80	625,00
HFN10-3-80	-	80A	4 / 16	1940,00
HFN10-3-100	-	100A	4 / 16	2000,00
HFN10-3-125	-	125A	4 / 16	2111,00

10 kA



TS 5018-1 EN 60898-1  
ISO 9001:2000





## 2 Kutuplu Otomatik Sigortalar (B ve C Tipi)

Sipariş Kodu B/C Eğrisi için	Sipariş Kodu B/C Yerli Üretim	Anma Akımı (A)	Kutu / Koli (Adet)	Birim Fiyatı (TL)
HFN10-2-06	FMC10-2-06	6A	6 / 120	348,00
HFN10-2-10	FMC10-2-10	10A	6 / 120	348,00
HFN10-2-16	FMC10-2-16	16A	6 / 120	348,00
HFN10-2-20	FMC10-2-20	20A	6 / 120	348,00
HFN10-2-25	FMC10-2-25	25A	6 / 120	348,00
HFN10-2-32	FMC10-2-32	32A	6 / 120	376,00
HFN10-2-40	FMC10-2-40	40A	6 / 120	406,00
HFN10-2-50	FMC10-2-50	50A	6 / 120	427,00
HFN10-2-63	FMC10-2-63	63A	6 / 120	447,00

10 kA



TS 5018-1 EN 60898-1  
ISO 9001:2000



## 4 Kutuplu Otomatik Sigortalar (B ve C Tipi)

Sipariş Kodu B/C Eğrisi için	Sipariş Kodu B/C Yerli Üretim	Anma Akımı (A)	Kutu / Koli (Adet)	Birim Fiyatı (TL)
HFN10-4-06	FMC10-4-06	6A	3 / 60	725,00
HFN10-4-10	FMC10-4-10	10A	3 / 60	725,00
HFN10-4-16	FMC10-4-16	16A	3 / 60	725,00
HFN10-4-20	FMC10-4-20	20A	3 / 60	725,00
HFN10-4-25	FMC10-4-25	25A	3 / 60	725,00
HFN10-4-32	FMC10-4-32	32A	3 / 60	791,00
HFN10-4-40	FMC10-4-40	40A	3 / 60	813,00
HFN10-4-50	FMC10-4-50	50A	3 / 60	834,00
HFN10-4-63	FMC10-4-63	63A	3 / 60	854,00

10 kA



TS 5018-1 EN 60898-1  
ISO 9001:2000



## Mekanik 2P Kaçak Akım Koruma Şalteri (Monofaze)

Sipariş Kodu	Anma Akımı(A)	Kutup Sayısı	Anma Kaçak İletme Akımı	Koruma Sınıfı	Kutu / Koli (Adet)	Birim Fiyatı (TL)
FRB-2P/25-30	25A	1P+N	30mA	Hayat Koruma	1 / 100	800,00
FRB-2P/32-30	32A	1P+N	30mA		1 / 100	800,00
FRB-2P/40-30	40A	1P+N	30mA		1 / 100	800,00
FRB-2P/63-30	63A	1P+N	30mA		1 / 100	850,00
FRB-2P/25-300	25A	1P+N	300mA	Yangın Koruma	1 / 100	800,00
FRB-2P/32-300	32A	1P+N	300mA		1 / 100	800,00
FRB-2P/40-300	40A	1P+N	300mA		1 / 100	800,00
FRB-2P/63-300	63A	1P+N	300mA		1 / 100	850,00

On/Off led göstergeli

10 kA



TS EN 61008-1  
TS EN 61008-2-1  
ISO 9001:2000



## Mekanik 4P Kaçak Akım Koruma Şalteri (Trifaze)

Sipariş Kodu	Anma Akımı(A)	Kutup Sayısı	Anma Kaçak İletme Akımı	Koruma Sınıfı	Kutu / Koli (Adet)	Birim Fiyatı (TL)
FRB-4P/25-30	25A	3P+N	30mA	Hayat Koruma	1 / 50	1130,00
FRB-4P/32-30	32A	3P+N	30mA		1 / 50	1130,00
FRB-4P/40-30	40A	3P+N	30mA		1 / 50	1130,00
FRB-4P/63-30	63A	3P+N	30mA		1 / 50	1265,00
FRB-4P/80-30	80A	3P+N	30mA		1 / 50	1598,00
FRB-4P/100-30	100A	3P+N	30mA		1 / 50	1650,00
FRB-4P/25-300	25A	3P+N	300mA	Yangın Koruma	1 / 50	1130,00
FRB-4P/32-300	32A	3P+N	300mA		1 / 50	1130,00
FRB-4P/40-300	40A	3P+N	300mA		1 / 50	1130,00
FRB-4P/63-300	63A	3P+N	300mA		1 / 50	1265,00
FRB-4P/80-300	80A	3P+N	300mA		1 / 50	1598,00
FRB-4P/100-300	100A	3P+N	300mA		1 / 50	1650,00

On/Off led göstergeli

10 kA



TS EN 61008-1  
TS EN 61008-2-1  
ISO 9001:2000



## Mekanik 2P Kaçak Akım Koruma Şalteri (Monofaze)

Sipariş Kodu	Anma Akımı(A)	Kutup Sayısı	Anma Kaçak İletme Akımı	Koruma Sınıfı	Kutu / Koli (Adet)	Birim Fiyatı (TL)
FRBY-2P/25-30	25A	1P+N	30mA	Hayat Koruma	1 / 100	800,00
FRBY-2P/32-30	32A	1P+N	30mA		1 / 100	800,00
FRBY-2P/40-30	40A	1P+N	30mA		1 / 100	800,00
FRBY-2P/63-30	63A	1P+N	30mA		1 / 100	850,00
FRBY-2P/25-300	25A	1P+N	300mA	Yangın Koruma	1 / 100	800,00
FRBY-2P/32-300	32A	1P+N	300mA		1 / 100	800,00
FRBY-2P/40-300	40A	1P+N	300mA		1 / 100	800,00
FRBY-2P/63-300	63A	1P+N	300mA		1 / 100	850,00

6 kA



TS 5018-1 EN 60898-1  
ISO 9001:2000



## Mekanik 4P Kaçak Akım Koruma Şalteri (Trifaze)

Sipariş Kodu	Anma Akımı(A)	Kutup Sayısı	Anma Kaçak İletme Akımı	Koruma Sınıfı	Kutu / Koli (Adet)	Birim Fiyatı (TL)
FRBY-4P/25-30	25A	3P+N	30mA	Hayat Koruma	1 / 50	1130,00
FRBY-4P/32-30	32A	3P+N	30mA		1 / 50	1130,00
FRBY-4P/40-30	40A	3P+N	30mA		1 / 50	1130,00
FRBY-4P/63-30	63A	3P+N	30mA		1 / 50	1265,00
FRBY-4P/25-300	25A	3P+N	300mA	Yangın Koruma	1 / 50	1130,00
FRBY-4P/32-300	32A	3P+N	300mA		1 / 50	1130,00
FRBY-4P/40-300	40A	3P+N	300mA		1 / 50	1130,00
FRBY-4P/63-300	63A	3P+N	300mA		1 / 50	1265,00

Çift indikatörü ■ ■

6 kA



TS 5018-1 EN 60898-1  
ISO 9001:2000





## Güç Kontaktörleri ve Termik Röleler





## 3 Kutuplu Güç Kontaktörleri - 230V AC (FLTC)

Sipariş Kodu	Anma Akımı AC-3 /AC5 (A)	Anma Gücü (Kw)	Anma Termik Akımı (A)	Yardımcı Kontakt	Kutu / Koli (Adet)	Birim Fiyatı (TL)
FLTC-09-10	9A	4	25	1NA	1 / 50	500,00
FLTC-09-01	9A	4	25	1NK	1 / 50	500,00
FLTC-12-10	12A	5,5	25	1NA	1 / 50	515,00
FLTC-12-01	12A	5,5	25	1NK	1 / 50	515,00
FLTC-18-10	18A	7,5	32	1NA	1 / 50	585,00
FLTC-18-01	18A	7,5	32	1NK	1 / 50	585,00
FLTC-25-10	25A	11	40	1NA	1 / 50	880,00
FLTC-25-01	25A	11	40	1NK	1 / 50	880,00
FLTC-32-10	32A	15	50	1NA	1 / 50	939,00
FLTC-32-01	32A	15	50	1NK	1 / 50	939,00
FLTC-40-11	40A	18,5	60	1NA+1NK	1 / 20	1878,00
FLTC-50-11	50A	22	80	1NA+1NK	1 / 20	2100,00
FLTC-65-11	65A	30	80	1NA+1NK	1 / 20	2300,00
FLTC-80-11	80A	37	125	1NA+1NK	1 / 20	2887,00
FLTC-95-11	95A	45	125	1NA+1NK	1 / 20	3100,00
FLTC-115-11	115A	55	200	1NA+1NK	1 / 4	8275,00
FLTC-150-11	150A	75	250	1NA+1NK	1 / 4	8524,00
FLTC-185-11	185A	90	275	1NA+1NK	1 / 4	11899,00
FLTC-225-11	225A	110	315	1NA+1NK	1 / 2	12485,00
FLTC-265-11	265A	132	350	1NA+1NK	1 / 2	18000,00



TS EN 60947-4-1  
ISO 9001:2008



## Termik Röleler (FTR1)

Sipariş Kodu	Termik Ayar Sahası (A)	Birlikte Kullanılacağı Kontaktör	Kutu / Koli (Adet)	Birim Fiyatı (TL)
FTR1-0,63	0,4-0,63A	FLTC-9A.....32A	1 / 50	475,00
FTR1-1	0,63-1A	FLTC-9A.....32A	1 / 50	475,00
FTR1-1,6	1-1,6A	FLTC-9A.....32A	1 / 50	475,00
FTR1-2,5	1,6-2,5A	FLTC-9A.....32A	1 / 50	475,00
FTR1-4	2,5-4A	FLTC-9A.....32A	1 / 50	475,00
FTR1-6	4-6A	FLTC-9A.....32A	1 / 50	475,00
FTR1-8	5,5-8A	FLTC-9A.....32A	1 / 50	475,00
FTR1-10	7-10A	FLTC-9A.....32A	1 / 50	475,00
FTR1-13	9-13A	FLTC-9A.....32A	1 / 50	475,00
FTR1-18	12-18A	FLTC-9A.....32A	1 / 50	475,00
FTR1-25	17-25A	FLTC-9A.....32A	1 / 50	475,00
FTR1-40	30-40A	FLTC-40A.....95A	1 / 50	1220,00
FTR1-50	37-50A	FLTC-40A.....95A	1 / 50	1220,00
FTR1-65	48-65A	FLTC-40A.....95A	1 / 50	1220,00



TS EN 60947-4-1  
ISO 9001:2008



## Kontaktör Yardımcı Kontakt Blokları ( FYK)

Sipariş Kodu	Birlikte Kullanılacağı Kontaktör	Yardımcı Kontakt	Kutu / Koli (Adet)	Birim Fiyatı (TL)
FYK-11	FLTC	1NA+1NK	1 / 100	120,00
FYK-22	FLTC	2NA+2NK	1 / 100	150,00



ISO 9001:2008



## 3 Kutuplu Güç Kontaktörleri - 230V AC (FLKC)

Sipariş Kodu	Anma Akımı AC-3 /AC5 (A)	Anma Gücü (Kw)	Anma Termik Akımı (A)	Yardımcı Kontak	Kutu / Koli (Adet)	Birim Fiyatı (TL)
FLKC-32-22	32A	15	50	2NO+2NC	1 / 40	1350,00
FLKC-40-22	40A	18,5	50	2NO+2NC	1 / 40	1600,00
FLKC-50-22	50A	22	80	2NO+2NC	1 / 20	3282,00
FLKC-65-22	65A	30	100	2NO+2NC	1 / 20	3500,00
FLKC-75-22	75A	37	110	2NO+2NC	1 / 20	4300,00
FLKC-85-22	85A	45	135	2NO+2NC	1 / 20	4400,00
FLKC-105-22	105A	55	160	2NO+2NC	1 / 8	9200,00



EN 60947-4-1  
ISO 9001:2008 CE



## Termik Röleler (FTR3)

Sipariş Kodu	Termik Ayar Sahası(A)	Nominal Anma 3*400 V (Kw)	Birlikte Kullanılacağı Kontaktör	Kutu / Koli (Adet)	Birim Fiyatı (TL)
FTR3-1	0,63-1A	0,25	FLKC-9A.....22A	1 / 50	670,00
FTR3-1,6	1-1,6A	0,37	FLKC-9A.....22A	1 / 50	670,00
FTR3-2,5	1,6-2,5A	0,55..0,75	FLKC-9A.....22A	1 / 50	670,00
FTR3-4	2,5-4A	1,1...1,5	FLKC-9A.....22A	1 / 50	670,00
FTR3-6	4-6A	2,20	FLKC-9A.....22A	1 / 50	670,00
FTR3-8	5-8A	3...3,7	FLKC-9A.....22A	1 / 50	670,00
FTR3-10	7-10A	4	FLKC-9A.....22A	1 / 50	670,00
FTR3-13	9-13A	5,5	FLKC-9A.....22A	1 / 50	670,00
FTR3-18	12-18A	7,5	FLKC-9A.....22A	1 / 50	670,00
FTR3-26	18-26A	11,0	FLKC-32A.....40A	1 / 50	950,00
FTR3-40	28-40A	18,5	FLKC-32A.....40A	1 / 50	950,00



EN 60947-4-1  
ISO 9001:2008 CE



## Modüler Kontaktörler (FLMC)

Sipariş Kodu	Anma Akımı (A)	Kutup Sayısı	Kontak Yapısı	Besleme Gerilimi (V)	Kutu / Koli (Adet)	Birim Fiyatı (TL)
FLMC-2-25-11	25	2	1NA - 1NK	230	1/140	440,00
FLMC-2-25-02	25	2	2NK	230	1/140	440,00
FLMC-2-40-02	40	2	2NK	230	1/70	876,00
FLMC-4-25-04	25	4	4NK	230	1/70	900,00
FLMC-4-40-04	40	4	4NK	230	1/50	1222,00
FLMC-4-40-22	40	4	2NA - 2NK	230	1/50	1222,00
FLMC-4-63-04	63	4	4NK	230	1/50	1250,00
FLMC-YK-11	YARDIMCI KONTAK		1NA - 1NK		1/100	260,00



ISO 9001:2008 CE



## 3 Kutuplu Güç Kontaktörleri - 230V AC (FLSC)

Sipariş Kodu	Anma Akımı AC-3 / AC5 (A)	Anma Gücü (Kw)	Anma Termik Akımı (A)	Yardımcı Kontakt	Kutu / Koli (Adet)	Birim Fiyatı (TL)
FLSC-4010-9	9A	4	20	1NA	1 / 50	855,00
FLSC-4001-9	9A	4	20	1NK	1 / 50	855,00
FLSC-4011-9	9A	4	20	1NA+1NK	1 / 50	855,00
FLSC-4022-9	9A	4	20	2NA+2NK	1 / 50	855,00
FLSC-4110-12	12A	5,5	20	1NA	1 / 50	870,00
FLSC-4101-12	12A	5,5	20	1NK	1 / 50	870,00
FLSC-4111-12	12A	5,5	20	1NA+1NK	1 / 50	870,00
FLSC-4122-12	12A	5,5	20	2NA+2NK	1 / 50	870,00
FLSC-4210-16	16A	7,5	30	1NA	1 / 50	971,00
FLSC-4201-16	16A	7,5	30	1NK	1 / 50	971,00
FLSC-4211-16	16A	7,5	30	1NA+1NK	1 / 50	971,00
FLSC-4222-16	16A	7,5	30	2NA+2NK	1 / 50	971,00
FLSC-4310-22	22A	11	30	1NA	1 / 50	1000,00
FLSC-4301-22	22A	11	30	1NK	1 / 50	1000,00
FLSC-4311-22	22A	11	30	1NA+1NK	1 / 50	1000,00
FLSC-4322-22	22A	11	30	2NA+2NK	1 / 50	1000,00
FLSC-4422-32	32A	15	45	2NA+2NK	1 / 24	1550,00
FLSC-4522-38	38A	18	45	2NA+2NK	1 / 24	1620,00
FLSC-4622-45	45A	22	70	2NA+2NK	1 / 16	3071,00
FLSC-4722-63	63A	30	70	2NA+2NK	1 / 16	3291,00
FLSC-4822-75	75A	37	90	2NA+2NK	1 / 8	5282,00
FLSC-4922-85	85A	45	90	2NA+2NK	1 / 8	5748,00
FLSC-5022-110	110A	55	150	2NA+2NK	1 / 6	8490,00
FLSC-5122-140	140A	75	150	2NA+2NK	1 / 6	9500,00
FLSC-5222-170	170A	90	220	2NA+2NK	1 / 4	12898,00
FLSC-5322-205	205A	110	220	2NA+2NK	1 / 4	14500,00
FLSC-5422-250	250A	132	300	2NA+2NK	1 / 2	20726,00
FLSC-5522-300	300A	160	300	2NA+2NK	1 / 2	21450,00
FLSC-5622-400	400A	200	475	2NA+2NK	1 / 2	30000,00



EN 60947-4-1  
ISO 9001:2008 CE



EN 60947-4-1  
ISO 9001:2008 CE



## Termik Röleler (FTR2)

Sipariş Kodu	Termik Ayar Sahası(A)	Birlikte Kullanılacağı Kontaktör	Kutu / Koli (Adet)	Birim Fiyatı (TL)
FTR2-0,63	0,4-0,63A	FLSC / FLTC	1 / 50	843,00
FTR2-1	0,63-1A	FLSC / FLTC	1 / 50	843,00
FTR2-1,6	1-1,6A	FLSC / FLTC	1 / 50	843,00
FTR2-2,5	1,6-2,5A	FLSC / FLTC	1 / 50	843,00
FTR2-4	2,5-4A	FLSC / FLTC	1 / 50	843,00
FTR2-6,3	4-6,3A	FLSC / FLTC	1 / 50	843,00
FTR2-8	5-8A	FLSC / FLTC	1 / 50	843,00
FTR2-10	6,3-10A	FLSC / FLTC	1 / 50	843,00
FTR2-12,5	8-12,5A	FLSC / FLTC	1 / 50	843,00
FTR2-16	10-16A	FLSC / FLTC	1 / 50	843,00
FTR2-20	12,5-20A	FLSC / FLTC	1 / 50	843,00
FTR2-25	16-25A	FLSC / FLTC	1 / 50	843,00
FTR2-32	20-32A	FLSC / FLTC	1 / 50	843,00
FTR2-40	25-40A	FLSC / FLTC	1 / 50	890,00
FTR2-57	40-57A	FLSC / FLTC	1 / 50	890,00
FTR2-63	50-63A	FLSC / FLTC	1 / 50	890,00



EN 60947-4-1  
ISO 9001:2008 CE



## 4 Kutuplu Güç Kontaktörleri - 230V AC (FLTC4)

Sipariş Kodu	Anma Akımı AC-3 /AC5 (A)	Anma Gücü (Kw)	Anma Termik Akımı (A) AC1	Yardımcı Kontakt	Kutu / Koli (Adet)	Birim Fiyatı (TL)
FLTC-4P-09	9A	4	20	-	1 / 50	665,00
FLTC-4P-12	12A	5,5	20	-	1 / 50	680,00
FLTC-4P-25	25A	11	40	-	1 / 50	1293,00
FLTC-4P-40	40A	18,5	60	-	1 / 12	2750,00
FLTC-4P-50	50A	22	80	-	1 / 12	2849,00
FLTC-4P-65	65A	30	80	-	1 / 12	3000,00
FLTC-4P-80	80A	37	125	-	1 / 10	3750,00
FLTC-4P-95	95A	45	125	-	1 / 10	3944,00
FLTC-4P-115	115A	55	200	-	1 / 4	12882,00
FLTC-4P-150	150A	75	200	-	1 / 4	13139,00
FLTC-4P-185	185A	90	275	-	1 / 4	16557,00
FLTC-4P-225	225A	110	315	-	1 / 2	17500,00
FLTC-4P-265	265A	132	350	-	1 / 2	25000,00



EN 60947-4-1  
ISO 9001:2008



## Mini Güç Kontaktörleri - 230V AC (FLTC-M)

Sipariş Kodu	Anma Gücü (Kw)	Anma Akımı AC-3 /AC5 (A)	Anma Termik Akımı (A)	Yardımcı Kontakt	Kutu / Koli (Adet)	Birim Fiyatı (TL)
FLTC-M-0610	2,2	6A	20	1NA	1 / 100	550,00
FLTC-M-0601	2,2	6A	20	1NK	1 / 100	550,00
FLTC-M-0910	4	9A	20	1NA	1 / 100	575,00
FLTC-M-0901	4	9A	20	1NK	1 / 100	575,00
FLTC-M-1210	5,5	12A	20	1NA	1 / 100	700,00
FLTC-M-1201	5,5	12A	20	1NK	1 / 100	700,00
FLTC-M-1610	7,5	16A	20	1NA	1 / 100	740,00
FLTC-M-1601	7,5	16A	20	1NK	1 / 100	740,00



ISO 9001:2008



## Mini Termik Röleler (FTR3-M)

Sipariş Kodu	Anma Gücü (Kw)	Anma Akımı AC-3 /AC5 (A)	Birlikte Kullanılacağı Kontaktör	Kutu / Koli (Adet)	Birim Fiyatı (TL)
FTR3-M-1,6	1-1,6A	1,6	6A,9A,12A,16A	1 / 100	674,00
FTR3-M-2,5	1,6-2,5A	2,5	6A,9A,12A,16A	1 / 100	674,00
FTR3-M-4	2,5-4A	4	6A,9A,12A,16A	1 / 100	674,00
FTR3-M-6	4-6A	6	6A,9A,12A,16A	1 / 100	674,00
FTR3-M-9	6-9A	9	6A,9A,12A,16A	1 / 100	674,00
FTR3-M-13	9-13A	13	6A,9A,12A,16A	1 / 100	674,00
FTR3-M-16	12-16A	16	6A,9A,12A,16A	1 / 100	674,00



ISO 9001:2008







## Kompakt Şalterler



## 4 Kutuplu Kaçak Akım Algılamalı Yangın Korumalı (Sabit) Termik Manyetik Kompakt Şalterler (Açtırma Bobinli + Yardımcı Kontaklı)

Sipariş Kodu	Anma Akımı (A)	Anma Kısa Kısa Devre Kesme Kapasitesi (Icu)	Epik Zamanı (ms)	Epik Akımı (mA)	Kutu / Koli (Adet)	Birim Fiyatı (TL)
FHL-40	40A	30kA	0,1-0,3-0,5	30-300-500	1 / 8	7600,00
FHL-63	63A	30kA	0,1-0,3-0,5	30-300-500	1 / 8	7800,00
FHL-80	80A	30kA	0,1-0,3-0,5	30-300-500	1 / 8	8000,00
FHL-100	100A	30kA	0,1-0,3-0,5	30-300-500	1 / 8	8200,00
FHL-125	125A	30kA	0,1-0,3-0,5	30-300-500	1 / 8	8350,00
FHL-160	160A	30kA	0,1-0,3-0,5	30-300-500	1 / 8	8681,00
FHL-200	200A	30kA	0,1-0,3-0,5	30-300-500	1 / 8	9812,00
FHL-250	250A	30kA	0,1-0,3-0,5	30-300-500	1 / 8	9930,00
FHL-315	315A	50kA	0,1-0,3-0,5	30-300-500	1 / 2	23500,00
FHL-400	400A	50kA	0,1-0,3-0,5	30-300-500	1 / 2	24000,00



TS EN 60947-2  
ISO 9001:2008



**Not:** FHL-315 ve FHL-400 tip devre kesiciler bakır baralı olarak sevk edilir.

## 4 Kutuplu Kaçak Akım Algılamalı Yangın Korumalı (Ayar Sahalı) Termik Manyetik Kompakt Şalterler (Açtırma Bobinli)

Sipariş Kodu	Anma Akımı (A)	Anma Kısa Kısa Devre Kesme Kapasitesi (Icu)	Epik Zamanı (ms)	Epik Akımı (mA)	Kutu / Koli (Adet)	Birim Fiyatı (TL)
FHL-32-40	32-40A	30kA	0,1-0,3-0,5	30-300-500	1 / 8	7350,00
FHL-50-63	50-63A	30kA	0,1-0,3-0,5	30-300-500	1 / 8	7600,00
FHL-63-80	63-80A	30kA	0,1-0,3-0,5	30-300-500	1 / 8	7750,00
FHL-80-100	80-100A	30kA	0,1-0,3-0,5	30-300-500	1 / 8	8000,00
FHL-100-125	100-125A	30kA	0,1-0,3-0,5	30-300-500	1 / 8	8200,00
FHL-125-160	125-160A	30kA	0,1-0,3-0,5	30-300-500	1 / 8	10500,00
FHL-160-200	160-200A	30kA	0,1-0,3-0,5	30-300-500	1 / 8	10850,00
FHL-200-250	200-250A	30kA	0,1-0,3-0,5	30-300-500	1 / 8	11000,00



EN 60947-2  
ISO 9001:2008



## 3 Kutuplu Sabit (FHD) Termik Manyetik Kompakt Şalterler

Sipariş Kodu	Tipi	Anma Akımı (A)	Anma Kısa Kısa Devre Kesme Kapasitesi (Icu)	Anma İletme Kısa Devre Kesme Kapasitesi (Ics)	Kutu / Koli (Adet)	Birim Fiyatı (TL)
FHD-32	FHD	32A	15kA	%50	1 / 20	1650,00
FHD-40	FHD	40A	15kA	%50	1 / 20	1700,00
FHD-50	FHD	50A	15kA	%50	1 / 20	1750,00
FHD-63	FHD	63A	15kA	%50	1 / 20	1800,00
FHD-80	FHD	80A	15kA	%50	1 / 12	2500,00
FHD-100	FHD	100A	15kA	%50	1 / 12	2550,00
FHD-125	FHD	125A	15kA	%50	1 / 12	2600,00
FHD-160	FHD	160A	15kA	%50	1 / 12	3500,00
FHD-200	FHD	200A	15kA	%50	1 / 12	5000,00
FHD-250	FHD	250A	15kA	%50	1 / 12	5150,00



TS EN 60947-2  
ISO 9001:2008



## 4 Kutuplu Sabit (FHD4) Termik Manyetik Kompakt Şalterler

Sipariş Kodu	Tipi	Anma Akımı (A)	Anma Kısa Kısa Devre Kesme Kapasitesi (Icu)	Anma İletme Kısa Devre Kesme Kapasitesi (Ics)	Kutu / Koli (Adet)	Birim Fiyatı (TL)
FHD4-63	FHD4	63A	15kA	%50	1 / 8	2500,00
FHD4-80	FHD4	80A	15kA	%50	1 / 8	3500,00
FHD4-100	FHD4	100A	15kA	%50	1 / 8	3600,00
FHD4-125	FHD4	125A	15kA	%50	1 / 8	3650,00
FHD4-160	FHD4	160A	15kA	%50	1 / 8	4674,00
FHD4-200	FHD4	200A	15kA	%50	1 / 8	6400,00
FHD4-250	FHD4	250A	15kA	%50	1 / 8	6550,00
FHD4-315	FHD4	315A	35kA	%50	1 / 2	22500,00
FHD4-400	FHD4	400A	35kA	%50	1 / 2	23000,00
FHD4-630	FHD4	630A	35kA	%50	1 / 2	38000,00



EN 60947-2  
ISO 9001:2008



**Not:** FHD4-315, FHD4-400 ve FHD4-630 tip devre kesiciler bakır baralı olarak sevk edilir.

## 3 Kutuplu Ayar Sahalı (FHQ) Termik Manyetik Kompakt Şalterler

Sipariş Kodu	Tipi	Anma Akımı (A)	Anma Kısa Kısa Devre Kesme Kapasitesi (Icu)	Anma İletme Kısa Devre Kesme Kapasitesi (Ics)	Kutu / Koli (Adet)	Birim Fiyatı (TL)
FHQ-40	FHQ	32-40A	35kA	%50	1 / 12	4300,00
FHQ-50	FHQ	40-50A	35kA	%50	1 / 12	4350,00
FHQ-63	FHQ	50-63A	35kA	%50	1 / 12	4400,00
FHQ-80	FHQ	63-80A	35kA	%50	1 / 12	4461,00
FHQ-100	FHQ	80-100A	35kA	%50	1 / 12	4514,00
FHQ-125	FHQ	100-125A	35kA	%50	1 / 12	4800,00
FHQ-160	FHQ	125-160A	35kA	%50	1 / 12	4860,00
FHQ-200	FHQ	160-200A	35kA	%50	1 / 12	5698,00
FHQ-250	FHQ	200-250A	35kA	%50	1 / 8	5862,00
FHQ-315	FHQ	250-315A	50kA	%50	1 / 2	17950,00
FHQ-400	FHQ	315-400A	50kA	%50	1 / 2	18478,00
FHQ-630	FHQ	500-630A	50kA	%50	1 / 2	32500,00

**Not:** FHQ-315, FHQ-400 ve FHQ-630 tip devre kesiciler bakır baralı olarak sevk edilir.



TS EN 60947-2  
ISO 9001:2008



## 4 Kutuplu Ayar Sahalı (FHQ4) Termik Manyetik Kompakt Şalterler (Açtırma Bobinli)

Sipariş Kodu	Tipi	Anma Akımı (A)	Anma Kısa Kısa Devre Kesme Kapasitesi (Icu)	Anma İletme Kısa Devre Kesme Kapasitesi (Ics)	Kutu / Koli (Adet)	Birim Fiyatı (TL)
FHQ4-63	FHQ4	50-63A	35kA	%50	1 / 8	6100,00
FHQ4-80	FHQ4	63-80A	35kA	%50	1 / 8	6200,00
FHQ4-100	FHQ4	80-100A	35kA	%50	1 / 8	6300,00
FHQ4-125	FHQ4	100-125A	35kA	%50	1 / 8	6600,00
FHQ4-160	FHQ4	125-160A	35kA	%50	1 / 8	7350,00
FHQ4-200	FHQ4	160-200A	35kA	%50	1 / 8	8900,00
FHQ4-250	FHQ4	200-250A	35kA	%50	1 / 8	9000,00
FHQ4-315	FHQ4	250-315A	50kA	%50	1 / 2	26500,00
FHQ4-400	FHQ4	315-400A	50kA	%50	1 / 2	27000,00
FHQ4-630	FHQ4	500-630A	50kA	%50	1 / 2	43500,00

**Not:** FHQ4-315, FHQ4-400 ve FHQ4-630 tip devre kesiciler bakır baralı olarak sevk edilir.



EN 60947-2  
ISO 9001:2008







## Darbe Akım Anahtarı

Sipariş Kodu	Teknik Özellik	Kutu / Koli (Adet)	Birim Fiyatı (TL)
FDA	16 A 230 V 1NO	12 / 120	550,00



ISO 9001:2008 CE



## Ray Tipi Topraklı Pano Prizi

Sipariş Kodu	Teknik Özellik	Kutu / Koli (Adet)	Birim Fiyatı (TL)
FPP	16A 230V Topraklı Priz	5 / 100	218,00



ISO 9001:2008 CE



## Düşük Gerilim Bobini

**Önemli not:** Bobin-Şalter trip konumundayken takılmalıdır.

Sipariş Kodu	Tipi	Birlikte Kullanılacağı Devre Kesici Tipi	Besleme Gerilimi (V)	Kutu / Koli (Adet)	Birim Fiyatı (TL)
DGB-160	DGB	FHL/FHQ/FHD-	220/380	10 / 120	1800,00
DGB-250	DGB	FHL/FHQ/FHD-	220/380	10 / 120	1975,00
DGB-400	DGB	FHL/FHQ/FHD-	220/380	10 / 120	2519,00



ISO 9001:2008 CE



## Sinyal ve Alarm Kontak

**Önemli not:** Bobin-Şalter trip konumundayken takılmalıdır.

Sipariş Kodu	Tipi	Birlikte Kullanılacağı Devre Kesici Tipi	Yardımcı Kontak	Kutu / Koli (Adet)	Birim Fiyatı (TL)
YKB-160	YKB	FHL/FHQ/FHD-	1NA+1NK	10 / 120	630,00
YKB-250	YKB	FHL/FHQ/FHD-	1NA+1NK	10 / 120	680,00
YKB-400	YKB	FHL/FHQ/FHD-	1NA+1NK	10 / 120	783,00



ISO 9001:2008 CE

## Kaçak Akım Algılama Rölesi

Sipariş Kodu	Epik Akımı (A)	Açma Süresi (S)	Kutu / Koli (Adet)	Birim Fiyatı (TL)
KAR	0,03-30A	0,03-3	1 / 36	3450,00



ISO 9001:2008 CE

## Kaçak Akım Algılama Rölesi Bağlantı Şeması

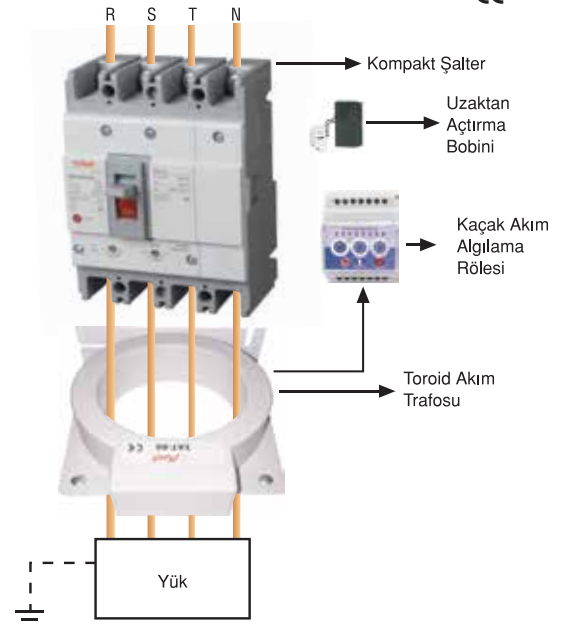
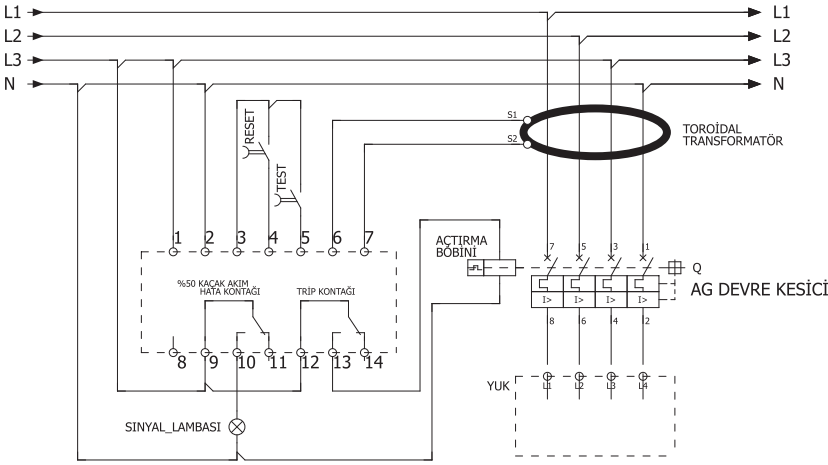

## Toroidal Akım Trafosmatörü

Sipariş Kodu	İç Çap $\Phi$ (mm)	Kutu / Koli (Adet)	Birim Fiyatı (TL)
TAT-40	40	1 / 36	820,00
TAT-55	55	1 / 20	1155,00
TAT-80	80	1 / 60	1190,00
TAT-110	110	1 / 40	1785,00



ISO 9001:2008 CE



## Açtırma Bobini

**Önemli not:** Bobin-Şalter trip konumundayken takılmalıdır.

Sipariş Kodu	Tipi	Birlikte Kullanılacağı Devre Kesici Tipi	Besleme Gerilimi (V)	Kutu / Koli (Adet)	Birim Fiyatı (TL)
FAB-160	FAB	FHL/FHQ/FHD-	220	10 / 120	920,00
FAB-250	FAB	FHL/FHQ/FHD-	220	10 / 120	1000,00
FAB-400	FAB	FHL/FHQ/FHD-	220	10 / 120	1890,00



ISO 9001:2008 CE



## Motor Koruma Şalteri

Sipariş Kodu	Termik Ayar Sahası (A)	Kullanılacak Motor Gücü (380 V AC) Kw	Kutu / Koli (Adet)	Birim Fiyatı (TL)
FMK-0,4	0,25-0,4A	0,9...0,12	1 / 50	1325,00
FMK-0,63	0,4-0,63A	0,18	1 / 50	1325,00
FMK-1	0,63-1A	0,25	1 / 50	1325,00
FMK-1,6	1-1,6A	0,37	1 / 50	1325,00
FMK-2,5	1,6-2,5A	0,55...0,75	1 / 50	1325,00
FMK-4	2,5-4A	1,1...1,5	1 / 50	1325,00
FMK-6,3	4-6,3A	2,2	1 / 50	1325,00
FMK-10	6,3-10A	4	1 / 50	1325,00
FMK-14	9-14A	5,5	1 / 50	1325,00
FMK-16	10-16A	7,5	1 / 50	1350,00
FMK-18	13-18A	7,5	1 / 50	1350,00
FMK-23	17-23A	11	1 / 50	1350,00
FMK-25	20-25A	11	1 / 50	1350,00
FMK-32	24-32A	15	1 / 50	1350,00
<b>FMK - UST11</b>	<b>1 NA - 1NK Yardımcı Kontak Blok (Üstten Montajlı)</b>		<b>1 / 10</b>	<b>232,00</b>
<b>FMK - YAN11</b>	<b>1 NA - 1NK Yardımcı Kontak Blok (Yandan Montajlı)</b>		<b>1 / 10</b>	<b>282,00</b>



## Analog Günlük Zaman Saati

Sipariş Kodu	Teknik Özellik	Kutu / Koli (Adet)	Birim Fiyatı (TL)
FZR100	Günlük 100 Saat Rezervli	25 / 100	750,00



ISO 9001:2008 CE

## Priz Modelli Zaman Saati

Sipariş Kodu	Teknik Özellik	Kutu / Koli (Adet)	Birim Fiyatı (TL)
FPZ24	Günlük Programlanabilir	16 / 80	325,00



ISO 9001:2008 CE

## Bakır Alüminyumlu (Bimetalik) Kablo Papuçları

Sipariş Kodu	K. Kesiti mm <sup>2</sup>	ØE	Øİ	L	ØT	L1	Kutu / Koli (Adet)	Birim Fiyatı (TL)
FKP-16	16 mm <sup>2</sup>	16	5,5	83	10,5	52	50 / 600	135,00
FKP-25	25 mm <sup>2</sup>	16	7	83	10,5	52	50 / 600	138,00
FKP-35	35 mm <sup>2</sup>	16	8,5	83	10,5	52	50 / 600	141,00
FKP-50	50 mm <sup>2</sup>	20	9,5	96	13	55	30 / 360	185,00
FKP-70	70 mm <sup>2</sup>	20	12	96	13	55	30 / 360	189,00
FKP-95	95 mm <sup>2</sup>	20	13	96	13	55	30 / 360	193,00
FKP-120	120 mm <sup>2</sup>	25	14	110	13	64	25 / 200	323,00
FKP-150	150 mm <sup>2</sup>	25	16	110	13	64	25 / 200	330,00
FKP-185	185 mm <sup>2</sup>	32	18	125	13	70	20 / 120	540,00
FKP-240	240 mm <sup>2</sup>	32	20	125	13	70	20 / 120	550,00



ISO 9001:2008 CE

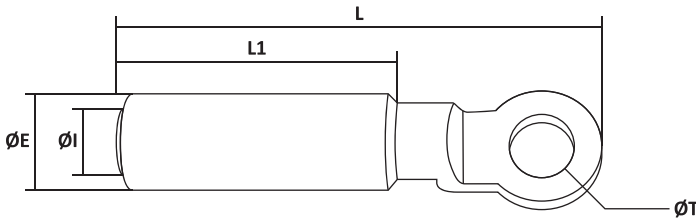

## Uzatma Barası

Sipariş Kodu	Tipi	Birlikte Kullanılacağı Devre Kesici Tipi	Kutu / Koli (Adet)	Birim Fiyatı (TL)
UZH-160	UZH	FHL/FHQ/FHD-	6 / 120	200,00



ISO 9001:2008 CE





## Sinyal Lambaları, Butonlar ve Ölçü Cihazları





## Voltmetre Göstergeli Ledli Sinyal Lambaları

Sipariş kodu	Anma Gerilimi (V)	Boyut (mm)	Renkler	Kutu / Koli (Adet)	Birim Fiyatı (TL)
AD16-22DV-R	50-450V AC	22	● Kırmızı	10 / 500	175,00
AD16-22DV-Y	50-450V AC	22	● Sarı	10 / 500	175,00
AD16-22DV-G	50-450V AC	22	● Yeşil	10 / 500	175,00



ISO 9001:2008 CE 

## Ampermetre Göstergeli Ledli Sinyal Lambaları

Sipariş kodu	Anma Gerilimi (A)	Boyut (mm)	Renkler	Kutu / Koli (Adet)	Birim Fiyatı (TL)
AD16-22AM-1R	0-100A	22	● Kırmızı	1 / 200	350,00
AD16-22AM-1Y	0-100A	22	● Sarı	1 / 200	350,00
AD16-22AM-1G	0-100A	22	● Yeşil	1 / 200	350,00
AD16-22AM-2R	0-200A	22	● Kırmızı	1 / 200	420,00
AD16-22AM-2Y	0-200A	22	● Sarı	1 / 200	420,00
AD16-22AM-2G	0-200A	22	● Yeşil	1 / 200	420,00



ISO 9001:2008 CE 

## Voltmetre&Ampermetre Göstergeli Ledli Sinyal Lambaları

Sipariş kodu	Anma Gerilimi (A-V)	Boyut (mm)	Renkler	Kutu / Koli (Adet)	Birim Fiyatı (TL)
AD16-22VA-1R	50-450V AC / 0-100A	22	● Kırmızı	1 / 200	530,00
AD16-22VA-1Y	50-450V AC / 0-100A	22	● Sarı	1 / 200	530,00
AD16-22VA-1G	50-450V AC / 0-100A	22	● Yeşil	1 / 200	530,00
AD16-22VA-2R	50-450V AC / 0-200A	22	● Kırmızı	1 / 200	610,00
AD16-22VA-2Y	50-450V AC / 0-200A	22	● Sarı	1 / 200	610,00
AD16-22VA-2G	50-450V AC / 0-200A	22	● Yeşil	1 / 200	610,00













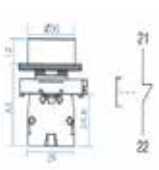

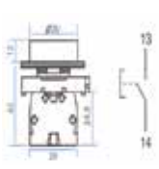
ISO 9001:2008 CE 

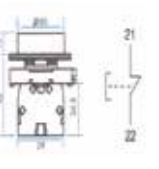
## Sinyal Lambaları, Buton ve Anahtarlar

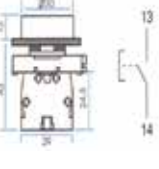
	Teknik Ölçü	Açıklama	Sipariş Kodu	Renkler	Kutu / Koli (Adet)	Birim Fiyatı (TL)
		Sinyal Lambası	SB7-EV640	● Kırmızı	10 / 500	24,00
		(Ampul Dahil)	SB7-EV650	● Sarı	10 / 500	24,00
		220V / 50Hz	SB7-EV630	● Yeşil	10 / 500	24,00
		Sinyal Lambası	SB7-EV740	● Kırmızı	10 / 500	24,00
		(Ampul Dahil)	SB7-EV750	● Sarı	10 / 500	24,00
		24V / AC	SB7-EV730	● Yeşil	10 / 500	24,00
			SB7-EV710	○ Beyaz	10 / 500	24,00
		SB7-EV760	● Mavi	10 / 500	24,00	
		<b>SMD Ledli</b>	AD16-22DS-R	● Kırmızı	10 / 500	37,00
		4 Çipli	AD16-22DS-Y	● Sarı	10 / 500	37,00
		AC 12-450V	AD16-22DS-G	● Yeşil	10 / 500	37,00
		LED'li	AD22-24DS-R	● Kırmızı	10 / 500	35,00
		Sinyal Lambası	AD22-24DS-Y	● Sarı	10 / 500	35,00
		(Dahili Korumalı)	AD22-24DS-G	● Yeşil	10 / 500	35,00
		24V / AC / DC	AD22-24DS-W	○ Beyaz	10 / 500	35,00
			AD22-24DS-B	● Mavi	10 / 500	35,00
		LED'li Buzzer				
		(Dahili Korumalı)	AD22-22SM	● Kırmızı	10 / 500	108,00
		220V / 50Hz	AD22-24SM	● Kırmızı	10 / 500	108,00
		24V / AC / DC				
		Buzzer	AD22-22FM	● Siyah	10 / 400	100,00
		220V / 50Hz	AD22-24FM	● Siyah	10 / 400	100,00
		24V / AC / DC				

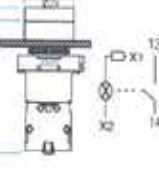
## Sinyal Lambaları, Buton ve Anahtarlar

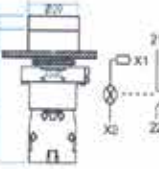
Teknik Ölçü	Açıklama	Sipariş Kodu	Renkler	Kutu / Koli (Adet)	Birim Fiyatı (TL)
 	Start Butonu				
	1 N/A 400V 10(6)A	LAY5-EA310	● Yeşil	20 / 200	62,00
 	Stop Butonu				
	1 N/K 400V 10(6)A	LAY5-EA420	● Kırmızı	20 / 200	62,00
 	İşaretli Start Butonu				
	1 N/A 400V 10(6)A	LAY5-EA3351	● Yeşil	20 / 200	74,00
 	İşaretli Stop Butonu				
	1 N/K 400V 10(6)A	LAY5-EA4342	● Kırmızı	20 / 200	74,00
 	İşaretli Start Butonu				
	1 N/A 400V 10(6)A	LAY5-EA5321	● Siyah	20 / 200	74,00
 	LED'li Yaylı Start Butonu	LAY5-EW3171	○ Beyaz	20 / 240	160,00
	(Dahili Korumalı)	LAY5-EW3671	● Mavi	20 / 240	160,00
	1 N/A 220V	LAY5-EW3571	● Sarı	20 / 240	160,00
 	LED'li Yaylı Stop Butonu				
	(Dahili Korumalı)	LAY5-EW3472	● Kırmızı	20 / 240	160,00
1 N/K 220V					

## Sinyal Lambaları, Buton ve Anahtarlar

	Teknik Ölçü	Açıklama	Sipariş Kodu	Renkler	Kutu / Koli (Adet)	Birim Fiyatı (TL)
		Start & Stop Butonu 1 N/A + 1/NK 400V 10(6)A	LAY5-EL8325	● Yeşil-Kırmızı	20 / 240	138,00
		Işıklı Start & Stop Butonu 1 N/A + 1 N/K IP40 (Ampul Dahil)	LAY5-EW8465-N	● Yeşil-Kırmızı-Sarı	20 / 240	210,00
		Mantar Kafa Kayıcı 1 N/K 400V 10(6)A	LAY5-EC420	● Kırmızı	20 / 240	85,00
		Mantar Kafa Çek Çevir 1 N/K 400V 10(6)A	LAY5-ES542	● Kırmızı	20 / 200	105,00
		Mantar Kafa Kayıcı 1 N/A 400V 10(6)A	LAY5-EC310	● Yeşil	20 / 240	85,00
		Mantar Kafa Anahtarlı 1 N/K 400V 10(6)A	LAY5-ES142	● Kırmızı	20 / 240	218,00
		Start Kontak Bloğu 1 N/A 400V 10(6)A	LAY5-BE101	● Yeşil	100 / 1200	26,00
		Stop Kontak Bloğu 1 N/K 400V 10(6)A	LAY5-BE102	● Kırmızı	100 / 1200	26,00

## Sinyal Lambaları, Buton ve Anahtarlar

Teknik Ölçü	Açıklama	Ürün Stok No	Renkler	Kutu / Koli (Adet)	Birim Fiyatı (TL)
 	<p>Kısa Mandal Buton Tek Taraf Kalıcı 1 N/A 400V 10(6)A</p>	LAY5-ED210	● Siyah	20 / 200	74,00
	<p>Kısa Mandal Buton Sağ-Sol Kalıcı 1 N/A+1NA 400V 10(6)A</p>	LAY5-ED330	● Siyah	20 / 200	98,00
 	<p>Kısa Mandal Buton Tek Taraf Kayıcı 1 N/A 400V 10(6)A</p>	LAY5-ED410	● Siyah	20 / 240	76,00
	<p>Kısa Mandal Buton Sağ-Sol Kayıcı 1 N/A+1NA 400V 10(6)A</p>	LAY5-ED530	● Siyah	20 / 240	102,00
 	<p>Uzun Mandal Buton Tek Taraf Kayıcı 1 N/A 400V 10(6)A</p>	LAY5-EJ410	● Siyah	20 / 240	76,00
	<p>Uzun Mandal Buton Sağ-Sol Kayıcı 1 N/A+1NA 400V 10(6)A</p>	LAY5-EJ530	● Siyah	20 / 240	102,00
 	<p>Anahtarlı Buton Tek Taraf Kalıcı 1 N/A 400V 10(6)A</p>	LAY5-EG210	● Siyah	20 / 240	164,00
	<p>Anahtarlı Buton Tek Taraf Kayıcı 1 N/A+1NA 400V 10(6)A</p>	LAY5-EG410	● Siyah	20 / 240	164,00
 	<p>Anahtarlı Buton Sağ-Sol Kalıcı 1 N/A+1NA 400V 10(6)A</p>	LAY5-EG330	● Siyah	20 / 240	188,00
	<p>Anahtarlı Buton Sağ-Sol Kayıcı 1 N/A+1NA 400V 10(6)A</p>	LAY5-EG530	● Siyah	20 / 240	188,00







Yetkili Bayii

[www.flashelektrik.com](http://www.flashelektrik.com)

