

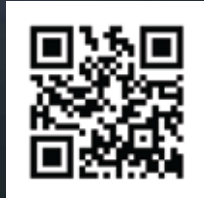

FIYAT LİSTESİ
2024-1



www.monoelectric.com.tr



BİR DOKUNUŞTAN FAZLASI

Mekanınızı fonksiyonel, ilham verici ve sofistike gösterecek **17 seri**.
Ve tek bir hedef; tüm beğeni ve istekleri karşılayarak dekorasyon ve stilinize mükemmel uyum sağlamak.





Mono Electric 2011 yılında 15.000 m² kapalı alanda kurulmuş İstanbul Hadımköydeki fabrikasında üretime başladı. Teknolojik yenilikleri yakından takip ederek sürekli gelişen Mono Electric, üretim süreçlerinin tamamında otomasyon yatırımları ile sektöründe öncü marka olmuştur. Sektöründe en yeni teknolojileri kullanan Mono Electric yüksek kalitede ürünler üretmektedir.

Mono Electric ürettiği tüm ürünlerde TSE, CE, TÜV Rheinland belgeleri alarak kalitesini tescillemiştir. Ayrıca tüm ürün dizaynlarını ve markalarını Türk Patent Enstitüsü tarafından dünyada 136 ülkede tescillendirmiştir. En modern teknolojik ekipmanlara sahip kalite laboratuvarlarında ISO 9001 kalite yönetim sistemine göre TSE, CE, TÜV Rheinland standartlarına göre ürettiği ürünlerin testlerini yapmaktadır.

Vizyonumuz:

- Yaşadığımız güven ortamını tüm dünya ile paylaşmak,
- İnsanlığın faydasına olacak ürünleri, onların istediği şartlarda sunmak,
- Faaliyet alanımızda, tasarımlarımızı dünyanın her yerinde en güvenilir, estetik ve ergonomik düzeyde sunmak.

Misyonumuz:

- Temsil ettiğimiz sektörde öncü rol üstlenmek,
- Ürünlerimizle, insanların güvenliğini, mutluluğunu ve faydasını gözetlemek,
- İnsanların beğenisine sunduğumuz ürünleri, en makul fiyatlara ulaştırmak.

Stratejimiz:

- En iyi teknolojileri etkin şekilde kullanmak,
- Hedef kitleye ulaşmada en etkin yolları kullanmak,
- En yeni, en cazip tekniklerle ürünlerimizi üretmek,
- İşletme kaynaklarını en etkin ve en verimli yöntemlerle kullanmak,
- Lider organizasyonların, sektörel deneyimlerinden faydalanarak onlarla aynı hataları tekrarlamamak,
- İletişim ve ulaşılabilirlikte en etkili yolları kullanmak.



İÇİNDEKİLER

8-11



despina

En Rahat Köşeniz

12-15



despina
metallic

Rahat ve Modern

16-19



larissa

Sıcak ve Rahat Mekanlar

20-23



larissa
wood

Sıcak ve Rahat Mekanlar

24-27

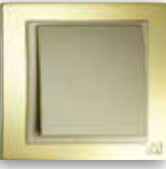

chrome

Fark Yaratın

28-31



Style
aluminium

İlham Veren Ritim ve Enerji

32-35



Style
glass

Lüksün Teknoloji ile Birleştiği Tasarım

36-39



Style
plexy

Yeni Stil Arayanlara, Yeni Seri

40-43



Style
wood

Doğal ve Zarif

44-47



LEON
MODULAR

En Popüler, En Modüler

48-53



LEON
MODULAR LUX

Lüks ve Zarif Modüler Çözümler

54-55



monte

Renkleri Seviyoruz

56-57



octans

Güvenliğiniz İçin

58-59



octans
IP54

Dış Koşullara Karşı Mükemmel Koruma

60-63



origin

İhtiyacınız Olan Her Yerde

64-65



accessories

Hızlı ve Pratik Çözümler

66-67



SİGORTA
KUTULARI

Halogen Free Özelliği

SİSTEM PRENSİBİ

TEK MEKANİZMA 9 SERİ

9 farklı renkte sunduğumuz düğme ve mekanizma opsiyonlarından birini seçip Larissa, Larissa Wood, Despina, Despina Metalik, Chrome, Style Alüminyum, Style Wood, Style Glass ve Style Plexy'nin sınırları zorlayan 31 farklı çerçeve seçeneğinden istediğiniz kombinasyonu siz oluşturun.

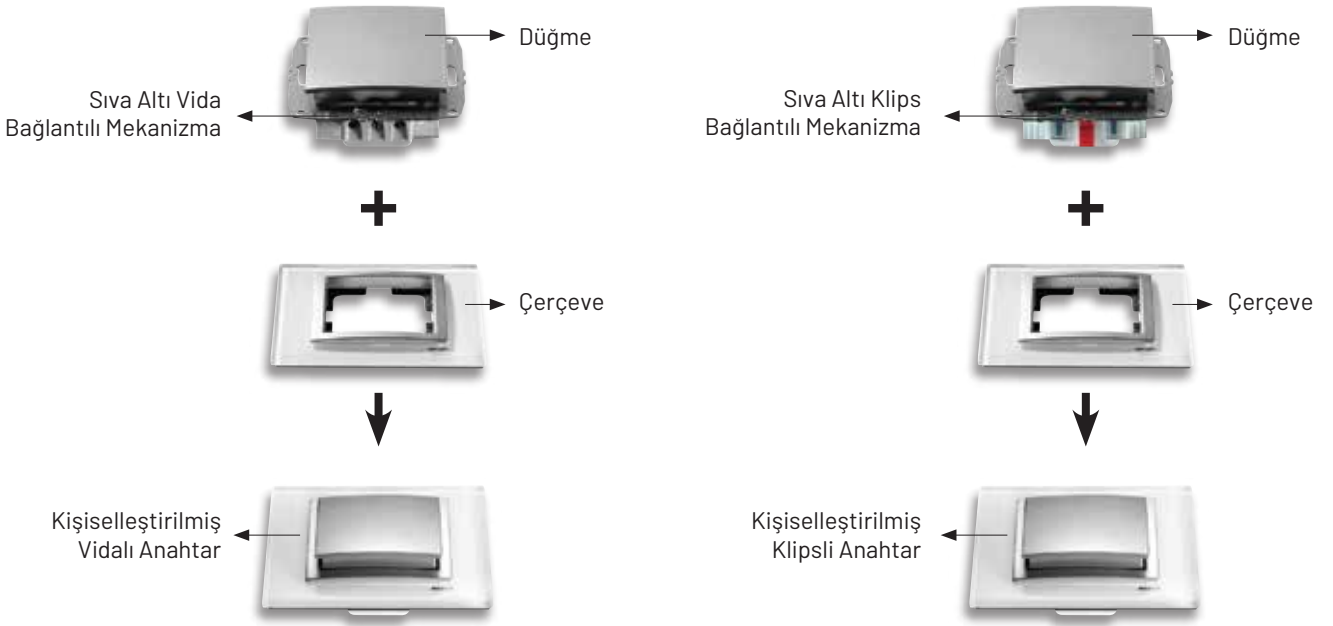

DÜĞME RENKLERİ



Beyaz



Krem



Meşe



Kiraz



Gümüş



Füme



Açık Füme



Titanyum



Antrasit

ÇERÇEVE RENKLERİ

despina



despina
metallic



larissa



larissa
wood

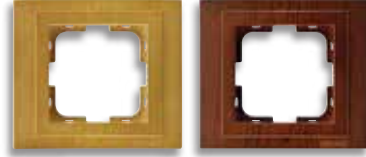

chrome

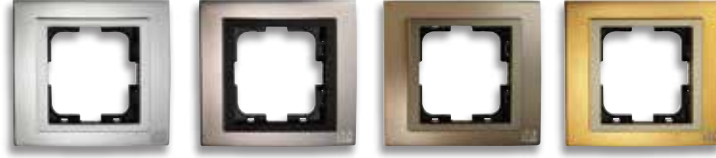

Style
aluminium



Style
glass



Style
plexi



Style
wood



despina



En **Rahat**
Köşeniz





SADE TASARIM - MİNİMAL HATLAR

Temel unsurlara odaklanan DESPİNA, sade ve çekici tasarım hayranları için ideal bir anahtar serisi. Form ve malzemede minimal çizgi prensibi ile tasarlanan DESPİNA, doğrusal bir tasarıma ve keskin bir görünüme dayanıyor. DESPİNA'nın beyaz ve krem olmak üzere 2 renk seçeneği bulunuyor.

RENKLER



Beyaz



Krem



Mono'nun
En Asil Karesi

GÖRSEL	VİDALI KOD	ÜRÜN ADI	FİYAT (TL)	KOLİ ADET
ANAHTAR GRUBU				
	500-00XX25-100	L-D Anahtar	80,73	120
	500-00XX25-102	L-D Komitatör	109,44	120
	500-00XX25-109	L-D Veavien	110,81	120
	500-00XX25-112	L-D Ara Veavien	189,37	60
	500-00XX23-111	L-D Komitatör Veavien	163,25	60
	500-00XX22-114	L-D Üçlü Anahtar	157,34	60
	500-00XX02-108	L-D Üçlü Veavien	191,54	60
	500-00XX25-105	L-D Light	92,50	120
	500-00XX25-107	L-D Zil	92,50	120
	500-00XX25-129	L-D Etiketli İsimli Zil	97,50	60
	500-00XX25-104	L-D Kapı Otomatiği	97,50	60
	500-00XX25-172	L-D Otomasyon Anahtarı	117,54	60
	500-00XX25-173	L-D Otomasyon Komitatör Tek Faz	126,25	60
	500-00XX25-174	L-D Otomasyon Komitatör Çift Faz	141,48	60
	500-00XX25-191	L-D Üçlü Light	176,31	60
	500-00XX25-113	L-D Jaluzi Kumanda	166,32	60
	500-00XX25-159	L-D Jaluzi Kumanda Tek Tuşlu	160,16	60
	500-00XX06-115	L-D Klima Anahtarı	282,96	60
500-00XX06-154	L-D Isıtıcı Anahtarı	282,96	60	
İŞIKLI ANAHTAR GRUBU				
	500-00XX25-101	L-D Işıklı Anahtar	152,36	60
	500-00XX25-103	L-D Işıklı Komitatör	163,25	60
	500-00XX25-106	L-D Işıklı Light	156,45	60
	500-00XX25-155	L-D Işıklı Zil (220V)	156,45	60
	500-00XX25-110	L-D Işıklı Veavien	165,42	60
PRİZ GRUBU				
	500-00XX22-116	L-D Priz	106,11	120
	500-00XX21-117	L-D Topraklı Priz	113,40	120
	500-00XX21-118	L-D Kapaklı Topraklı Priz	143,37	120
	500-00XX21-119	L-D Çocuk Korumalı Topraklı Priz	121,50	60
	500-00XX21-158	L-D Kapaklı Çocuk Korumalı Topraklı Priz	148,23	60
	500-00XX23-122	L-D UPS Priz	122,44	60
	500-00XX23-129	L-D UPS Priz Çocuk Korumalı	126,52	60
	500-001623-122	L-D UPS Priz Kırmızı	122,44	60
	500-00XX05-121	L-D İkili Priz	130,60	60
	500-00XX04-120	L-D İkili Topraklı Priz	153,05	60
	500-00XX04-123	L-D İkili Topraklı Priz Çocuk Korumalı	159,17	60
	102-XXXX04-120	Despina İkili Topraklı Priz (Komple)	209,21	50
	102-XXXX04-123	Despina İkili Topraklı Priz Çocuk Korumalı (Komple)	212,36	50

XX: 01 BEYAZ, 17 KREM

GÖRSEL	VİDALI KOD	ÜRÜN ADI	FİYAT (TL)	KOLİ ADET
İLETİŞİM GRUBU				
	500-00XX05-124	L-D Numeris Telefon Prizi (Rj11)	119,23	120
	500-00XX25-124	L-D Numeris Telefon Prizi (Cat3 Model)	152,36	120
	500-00XX05-176	L-D İkili Numeris (RJ11 + RJ11)	141,48	60
	500-00XX05-131	L-D İkili Numeris Telefon Prizi (2 x Cat3)	239,43	60
	500-00XX05-125	L-D Data Prizi (Cat6)	293,04	60
	500-00XX05-182	L-D Data Prizi (Cat6) Toz Kapaklı	311,26	60
	500-00XX05-190	L-D Data Prizi (Cat6A)	311,26	60
	500-00XX05-126	L-D İkili Data Prizi (2 x Cat6)	367,31	60
	500-00XX05-183	L-D İkili Data Prizi (2 x Cat6) Toz Kapaklı	395,06	60
	500-00XX05-202	L-D İkili Data Prizi (2 x Cat6A)	395,06	60
	500-00XX05-132	L-D Data + Numeris Telefon Prizi (Cat6 x Cat3)	272,08	60
	500-00XX05-184	L-D Numeris Cat3+F Konnektör	195,90	60
	500-00XX05-185	L-D Data Cat6+F Konnektör	282,96	60
	500-00XX05-130	L-D F Konnektör Bağlantı Aparatı	138,24	120
	500-00XX05-127	L-D TV Priz Sonlu Dışı F Konnektör Bağlantılı	152,36	120
	500-00XX05-137	L-D TV Priz Ekran Geçişli Dışı	195,90	120
	500-00XX05-138	L-D TV Priz Ekran Sonlu Dışı	195,90	120
	500-00XX05-170	L-D TV Priz Ekranlı Geçişli Erkek	195,90	120
	500-00XX05-171	L-D TV Priz Ekranlı Sonlu Erkek	195,90	120
	500-00XX05-148	L-D Tekli Uydu Prizi Geçişli	228,55	60
	500-00XX05-149	L-D Tekli Uydu Prizi Sonlu	228,55	60
	500-00XX05-139	L-D TV + Sat - Geçişli	435,33	60
	500-00XX05-140	L-D TV + Sat - Sonlu	435,33	60
	500-00XX07-146	L-D TV-R-Sat Geçişli	522,39	60
	500-00XX05-142	L-D 2'li Müzik Yayın Prizi	544,16	60
	500-00XX05-181	L-D Audio Prizi	457,09	12
	500-00XX05-180	L-D VGA Prizi	870,66	12
	500-00XX05-144	L-D USB Data	217,66	12
	500-00XX05-145	L-D HDMI Data	304,73	12
	500-00XX05-195	L-D HDMI + USB Priz	413,56	12
	500-00XX05-197	L-D Fiber Data Prizi (Mavi)	121,89	30
	YENİ	500-00XX05-203	L-D USB + TYPE C Şarj Prizi	696,52
	500-00XX05-150	L-D Data Prizi (Soketsiz)	99,36	60
	500-00XX05-151	L-D İkili Data Prizi (Soketsiz)	99,36	60
	500-00XX05-175	L-D Kablo Çıkış Kapağı	99,36	60
ELEKTRONİK GRUBU				
	500-00XX05-136	L-D Energy Saver Optik (24V)	587,69	1
	500-00XX05-152	L-D Energy Saver Mekanik (220V)	136,04	30
	500-00XX25-136	L-D RFID Energy Saver 13.56 MHZ	2.394,30	1
	500-00XX25-201	L-D RFID Energy Saver Boş Modül	108,83	1
	500-00XX05-134	L-D Dimmer 800W	435,33	30
	500-00XX05-135	L-D Dimmer Filtreli 500W	870,66	30
	500-00XX05-147	L-D Veavien Dimmer 300W	870,66	30
	500-00XX05-179	L-D RC Dimmer 3W-250W LED	1.305,98	30
	500-00XX06-123	L-D Müzik Yayın Anahtarı	609,46	12
	500-00XX05-133	L-D Buzzer Zil	348,26	30
	210-010500-012	Energy Saver Röle VRV RFID 2x16A 13.56 MHZ	2.176,64	1
	210-000600-014	Energy Saver Röle VRV RFID 3x16A 13.56 MHZ	2.394,30	1
	210-000600-001	Energy Saver Röle 1x16A + 1x30A	2.285,47	1
	210-000600-004	Energy Saver Röle 2x16A	2.067,81	1
	500-00XX05-186	L-D Otel Uyarı Sistemi İç Ünite	124,70	1
	500-00XX05-187	L-D Otel Uyarı Sistemi Dış Ünite	304,73	1
	210-000600-002	Energy Saver Yan Çizgili Kart Optik	152,36	1
	210-000600-015	Energy Saver Kart RFID 13.56 MHZ	174,13	1
	210-000600-016	Energy Saver Kart-Optik Modüler	152,36	1
	210-000600-007	Kapı ve Pencere Switch	206,78	1
	ÇERÇEVE GRUBU			
	102-XX0000-160	Despina Tekli Çerçeve	12,38	120
	102-XX0000-161	Despina İkili Çerçeve	60,21	80
	102-XX0000-162	Despina Üçlü Çerçeve	96,10	85
	102-XX0000-163	Despina Dörtlü Çerçeve	103,02	40
	102-XX0000-164	Despina Beşli Çerçeve	119,89	40
	102-XX0000-166	Despina Altılı Çerçeve	141,48	40
	102-XX0000-165	Despina İkili Priz Çerçeve	53,19	80

XX: 01 BEYAZ, 17 KREM

despina
metallic



Rahat ve
Modern





GEOMETRİK KONSEPT - STİL SAHİBİ RENK ARALIĞI

DESPİNA METALİK tasarımı, esnek, modern bir anahtar serisinin tüm işlevselliğini sunar. Geometrik konsepti; "maksimum düğme alanı-minimum çerçeve" ile mümkün olan en geniş kontrol yüzeyi sağlanmış olur. Gümüş, Titanyum, Füme, Açık Füme ve Antrasit ile 5 renkten oluşan şık bir renk aralığı sunar.

RENKLER



Gümüş



Füme







Açık Füme



Titanyum



Antrasit

GÖRSEL	VİDALI KOD	ÜRÜN ADI	FİYAT (TL)	KOLİ ADET
ANAHTAR GRUBU				
	500-00XX25-100	L-D Metalik Anahtar	102,35	60
	500-00XX25-102	L-D Metalik Komitatör	138,24	60
	500-00XX25-109	L-D Metalik Veavien	139,97	60
	500-00XX25-112	L-D Metalik Ara Veavien	231,42	60
	500-00XX23-111	L-D Metalik Komitatör Veavien	202,77	60
	500-00XX22-114	L-D Metalik Üçlü Anahtar	190,72	60
	500-00XX02-108	L-D Metalik Üçlü Veavien	231,42	60
	500-00XX25-105	L-D Metalik Light	116,25	60
	500-00XX25-107	L-D Metalik Zil	116,25	60
	500-00XX25-129	L-D Metalik Etiketli İsimli Zil	117,50	60
	500-00XX25-104	L-D Metalik Kapı Otomatığı	116,25	60
	500-00XX25-172	L-D Metalik Otomasyon Anahtarı	168,61	60
	500-00XX25-173	L-D Metalik Otomasyon Komitatör Tek Faz	179,08	60
	500-00XX25-174	L-D Metalik Otomasyon Komitatör Çift Faz	192,85	60
	500-00XX25-191	L-D Metalik Üçlü Light	218,20	60
	500-00XX25-113	L-D Metalik Jaluzi Kumanda	209,44	60
	500-00XX25-159	L-D Metalik Jaluzi Kumanda Tek Tuşlu	197,12	60
	500-00XX06-115	L-D Metalik Klima Anahtarı	319,58	60
500-00XX06-154	L-D Metalik Isıtıcı Anahtarı	319,58	60	
IŞIKLI ANAHTAR GRUBU				
	500-00XX25-101	L-D Metalik Işıklı Anahtar	187,34	60
	500-00XX25-103	L-D Metalik Işıklı Komitatör	198,36	60
	500-00XX25-106	L-D Metalik Işıklı Light	192,85	60
	500-00XX25-155	L-D Metalik Işıklı Zil (220V)	192,85	60
	500-00XX25-110	L-D Metalik Işıklı Veavien	200,56	60
PRİZ GRUBU				
	500-00XX22-116	L-D Metalik Priz	136,37	60
	500-00XX21-117	L-D Metalik Topraklı Priz	141,75	60
	500-00XX21-118	L-D Metalik Kapaklı Topraklı Priz	177,39	60
	500-00XX21-119	L-D Metalik Çocuk Korumalı Topraklı Priz	149,85	60
	500-00XX21-158	L-D Metalik Kapaklı Çocuk Korumalı Topraklı Priz	182,25	60
	500-00XX23-122	L-D Metalik UPS Priz	152,90	60
	500-00XX23-129	L-D Metalik UPS Priz Çocuk Korumalı	157,04	60
	500-00XX05-121	L-D Metalik İkili Priz	165,30	60
	500-00XX04-120	L-D Metalik İkili Topraklı Priz	185,96	60
	500-00XX04-123	L-D Metalik İkili Topraklı Priz Çocuk Korumalı	190,10	60
	102-XXXX04-120	Despina Metalik İkili Topraklı Priz (Komple)	275,17	50
102-XXXX04-123	Despina Metalik İkili Topraklı Priz Çocuk Korumalı (Komple)	278,81	50	
İLETİŞİM GRUBU				
	500-00XX05-124	L-D Metalik Numeris Telefon Prizi (RJ11)	150,14	60
	500-00XX25-124	L-D Metalik Numeris Telefon Prizi (Cat3 Model)	187,36	60
	500-00XX05-176	L-D Metalik İkili Numeris (RJ11 + RJ11)	176,32	60
	500-00XX05-131	L-D Metalik İkili Numeris Telefon Prizi (2 x Cat3)	286,52	60
	500-00XX05-125	L-D Metalik Data Prizi (Cat6)	319,68	60
	500-00XX05-182	L-D Metalik Data Prizi (Cat6) Toz Kapaklı	340,24	60
	500-00XX05-190	L-D Metalik Data Prizi (Cat6A)	340,24	60
	500-00XX05-126	L-D Metalik İkili Data Prizi (2 x Cat6)	409,12	60
	500-00XX05-183	L-D Metalik İkili Data Prizi (2 x Cat6) Toz Kapaklı	412,15	60
	500-00XX05-202	L-D Metalik İkili Data Prizi (2 x Cat6A)	412,15	60
	500-00XX05-132	L-D Metalik Data + Numeris Telefon Prizi (Cat6 x Cat3)	308,56	60
	500-00XX05-184	L-D Metalik Numeris Cat3+F Konnektör	223,16	60
	500-00XX05-185	L-D Metalik Data Cat6+F Konnektör	308,56	60
	500-00XX05-130	L-D Metalik F Konnektör Bağlantı Aparatı	176,64	60
	500-00XX05-127	L-D Metalik TV Priz Sonlu Dişi F Konnektör Bağlantılı	165,30	60
	500-00XX05-137	L-D Metalik TV Priz Ekran Geçişli Dişi	242,44	60
	500-00XX05-138	L-D Metalik TV Priz Ekran Sonlu Dişi	242,44	60
	500-00XX05-170	L-D Metalik TV Priz Ekranlı Geçişli Erkek	242,44	60
	500-00XX05-171	L-D Metalik TV Priz Ekranlı Sonlu Erkek	242,44	60
	500-00XX05-148	L-D Metalik Tekli Uydu Prizi Geçişli	275,50	60
	500-00XX05-149	L-D Metalik Tekli Uydu Prizi Sonlu	275,50	60
500-00XX05-139	L-D Metalik TV + Sat - Geçişli	484,88	60	

XX: 20 FÜME, 21 GÜMÜŞ, 22 TİTANYUM, 23 AÇIK FÜME, 24 ANTRASİT

GÖRSEL	VİDALI KOD	ÜRÜN ADI	FİYAT (TL)	KOLİ ADET
İLETİŞİM GRUBU				
	500-00XX05-140	L-D Metalik TV + Sat - Sonlu	484,88	60
	500-00XX07-146	L-D Metalik TV-R-Sat Geçişli	573,04	60
	500-00XX05-142	L-D Metalik 2'li Müzik Yayın Prizi	595,08	60
	500-00XX05-181	L-D Metalik Audio Prizi	495,90	12
	500-00XX05-180	L-D Metalik VGA Prizi	914,66	12
	500-00XX05-144	L-D Metalik USB Data	264,48	12
	500-00XX05-145	L-D Metalik HDMI Data	352,64	12
	500-00XX05-195	L-D Metalik HDMI + USB Priz	440,80	12
	500-00XX05-197	L-D Metalik Fiber Data Prizi (Mavi)	154,28	30
	YENİ 500-00XX05-203	L-D Metalik USB + TYPE C Şarj Priz	771,40	30
	500-00XX05-150	L-D Metalik Data Prizi (Soketsiz)	123,65	60
	500-00XX05-151	L-D Metalik İkili Data Prizi (Soketsiz)	123,65	60
	500-00XX05-175	L-D Metalik Kablo Çıkış Kapağı	123,65	60
ELEKTRONİK GRUBU				
	500-00XX05-136	L-D Metalik Energy Saver Optik (24V)	661,20	1
	500-00XX05-152	L-D Metalik Energy Saver Mekanik (220V)	151,53	30
	500-00XX25-136	L-D Metalik RFID Energy Saver	2.534,60	1
	500-00XX25-201	L-D Metalik RFID Energy Saver Boş Modül	132,24	1
	500-00XX05-134	L-D Metalik Dimmer 800W	484,88	30
	500-00XX05-135	L-D Metalik Dimmer Filtreli 500W	925,68	30
	500-00XX05-147	L-D Metalik Veavien Dimmer 300W	925,68	30
	500-00XX05-179	L-D Metalik RC Dimmer 3W-250W LED	1.366,48	30
	500-00XX06-123	L-D Metalik Müzik Yayın Anahtarı	661,20	12
	500-00XX05-133	L-D Metalik Buzzer Zil	371,93	30
	210-000600-012	Energy Saver Röle VRV RFID 2x16A 13.56 MHZ	2.204,00	1
	210-000600-014	Energy Saver Röle VRV RFID 3x16A 13.56 MHZ	2.424,40	1
	210-000600-001	Energy Saver Röle 1x16A + 1x30A	2.314,20	1
	210-000600-004	Energy Saver Röle 2x16A	2.093,80	1
	500-00XX05-186	L-D Metalik Otel Uyarı Sistemi İç Ünite	165,30	1
	500-00XX05-187	L-D Metalik Otel Uyarı Sistemi Dış Ünite	352,64	1
	210-000600-002	Energy Saver Yan Çizgili Kart Optik	154,28	1
	210-000600-015	Energy Saver Kart RFID 13.56 MHZ	176,32	1
	210-000600-016	Energy Saver Kart-Optik Modüler	154,28	1
	210-000600-007	Kapı ve Pencere Switch	209,38	1
ÇERÇEVE GRUBU				
	102-XX0000-160	Despina Metalik Tekli Çerçeve	39,42	120
	102-XX0000-161	Despina Metalik İkili Çerçeve	113,34	80
	102-XX0000-162	Despina Metalik Üçlü Çerçeve	157,70	85
	102-XX0000-163	Despina Metalik Dörtlü Çerçeve	175,36	40
	102-XX0000-164	Despina Metalik Beşli Çerçeve	223,52	40
	102-XX0000-166	Despina Metalik Altılı Çerçeve	242,44	40
	102-XX0000-165	Despina Metalik İkili Priz Çerçeve	88,71	80

DÜĞME RENK KODLARI



XX:20
Füme



XX:21
Gümüş

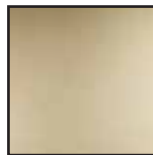

XX:22
Titanium



XX:23
Açık Füme



XX:24
Antrasit

Larissa



Sıcak ve Rahat Mekanlar





KORDON RENKLERİ



XX: 02 Gri



XX: 03 Yeşil



XX: 04 Bej



XX: 05 Açık Bej



XX: 06 Mavi



XX: 07 Açık Mavi



XX: 08 Kahve



XX: 09 Sarı



XX: 10 Açık Lila



XX: Koyu Lila



XX: 12 Pembe







XX: 13 Siyah





XX: 14 Bordo



XX: 15 Kremit

GÖRSEL	VİDALI KOD	ÜRÜN ADI	FİYAT (TL)	KOLİ ADET
ANAHTAR GRUBU				
	500-00XX25-100	L-D Anahtar	80,73	120
	500-00XX25-102	L-D Komitatör	109,44	120
	500-00XX25-109	L-D Veavien	110,81	120
	500-00XX25-112	L-D Ara Veavien	189,37	60
	500-00XX23-111	L-D Komitatör Veavien	163,25	60
	500-00XX22-114	L-D Üçlü Anahtar	157,34	60
	500-00XX02-108	L-D Üçlü Veavien	191,54	60
	500-00XX25-105	L-D Light	92,50	120
	500-00XX25-107	L-D Zil	92,50	120
	500-00XX25-129	L-D Etiketli İsimli Zil	97,50	60
	500-00XX25-104	L-D Kapı Otomatığı	97,50	60
	500-00XX25-172	L-D Otomasyon Anahtarı	117,54	60
	500-00XX25-173	L-D Otomasyon Komitatör Tek Faz	126,25	60
	500-00XX25-174	L-D Otomasyon Komitatör Çift Faz	141,48	60
	500-00XX25-191	L-D Üçlü Light	176,31	60
	500-00XX25-113	L-D Jaluzi Kumanda	166,32	60
	500-00XX25-159	L-D Jaluzi Kumanda Tek Tuşlu	160,16	60
	500-00XX06-115	L-D Klima Anahtarı	282,96	60
500-00XX06-154	L-D Isıtıcı Anahtarı	282,96	60	
İŞIKLI ANAHTAR GRUBU				
	500-00XX25-101	L-D Işıklı Anahtar	152,36	60
	500-00XX25-103	L-D Işıklı Komitatör	163,25	60
	500-00XX25-106	L-D Işıklı Light	156,45	60
	500-00XX25-155	L-D Işıklı Zil (220V)	156,45	60
	500-00XX25-110	L-D Işıklı Veavien	165,42	60
PRİZ GRUBU				
	500-00XX22-116	L-D Priz	106,11	120
	500-00XX21-117	L-D Topraklı Priz	113,40	120
	500-00XX21-118	L-D Kapaklı Topraklı Priz	143,37	120
	500-00XX21-119	L-D Çocuk Korumalı Topraklı Priz	121,50	60
	500-00XX21-158	L-D Kapaklı Çocuk Korumalı Topraklı Priz	148,23	60
	500-00XX23-122	L-D UPS Priz	122,44	60
	500-00XX23-129	L-D UPS Priz Çocuk Korumalı	126,52	60
	500-001623-122	L-D UPS Priz Kırmızı	122,44	60
	500-00XX05-121	L-D İkili Priz	130,60	60
	500-00XX04-120	L-D İkili Topraklı Priz	153,05	60
	500-00XX04-123	L-D İkili Topraklı Priz Çocuk Korumalı	159,17	60
	103-XXXX04-120	Larissa İkili Topraklı Priz (Komple)	209,21	50
	103-XXXX04-123	Larissa İkili Topraklı Priz Çocuk Korumalı (Komple)	212,36	50
	İLETİŞİM GRUBU			
	500-00XX05-124	L-D Numeris Telefon Prizi (Rj11)	119,23	120
	500-00XX25-124	L-D Numeris Telefon Prizi (Cat3 Model)	152,36	120
	500-00XX05-176	L-D İkili Numeris (RJ11 + RJ11)	141,48	60
	500-00XX05-131	L-D İkili Numeris Telefon Prizi (2 x Cat3)	239,43	60
	500-00XX05-125	L-D Data Prizi (Cat6)	293,04	60
	500-00XX05-182	L-D Data Prizi (Cat6) Toz Kapaklı	311,26	60
	500-00XX05-190	L-D Data Prizi (Cat6A)	311,26	60
	500-00XX05-126	L-D İkili Data Prizi (2 x Cat6)	367,31	60
	500-00XX05-183	L-D İkili Data Prizi (2 x Cat6) Toz Kapaklı	395,06	60
	500-00XX05-202	L-D İkili Data Prizi (2 x Cat6A)	395,06	60
	500-00XX05-132	L-D Data + Numeris Telefon Prizi (Cat6 x Cat3)	272,08	60
	500-00XX05-184	L-D Numeris Cat3+F Konnektör	195,90	60
	500-00XX05-185	L-D Data Cat6+F Konnektör	282,96	60
	500-00XX05-130	L-D F Konnektör Bağlantı Aparatı	138,24	120
	500-00XX05-127	L-D TV Priz Sonlu Dişi F Konn Bağlantılı	152,36	120
	500-00XX05-137	L-D TV Priz Ekran Geçişli Dişi	195,90	120
	500-00XX05-138	L-D TV Priz Ekran Sonlu Dişi	195,90	120
	500-00XX05-170	L-D TV Priz Ekranlı Geçişli Erkek	195,90	120
	500-00XX05-171	L-D TV Priz Ekranlı Sonlu Erkek	195,90	120
	500-00XX05-148	L-D Tekli Uydu Prizi Geçişli	228,55	60
	500-00XX05-149	L-D Tekli Uydu Prizi Sonlu	228,55	60
	500-00XX05-139	L-D TV + Sat - Geçişli	435,33	60

XX: 01 BEYAZ, 17 KREM

GÖRSEL	VİDALI KOD	ÜRÜN ADI	FİYAT (TL)	KOLİ ADET
İLETİŞİM GRUBU				
	500-00XX05-140	L-D TV + Sat - Sonlu	435,33	60
	500-00XX07-146	L-D TV-R-Sat Geçişli	522,39	60
	500-00XX05-142	L-D 2'li Müzik Yayın Prizi	544,16	60
	500-00XX05-181	L-D Audio Prizi	457,09	12
	500-00XX05-180	L-D VGA Prizi	870,66	12
	500-00XX05-144	L-D USB Data	217,66	12
	500-00XX05-145	L-D HDMI Data	304,73	12
	500-00XX05-195	L-D HDMI +USB Priz	413,56	12
	500-00XX05-197	L-D Fiber Data Prizi (Mavi)	121,89	30
	YENİ 500-00XX05-203	L-D USB + TYPE C Şarj Prizi	696,52	30
	500-00XX05-150	L-D Data Prizi (Soketsiz)	99,36	60
	500-00XX05-151	L-D İkili Data Prizi (Soketsiz)	99,36	60
	500-00XX05-175	L-D Kablo Çıkış Kapağı	99,36	60
ELEKTRONİK GRUBU				
	500-00XX05-136	L-D Energy Saver Optik (24V)	587,69	1
	500-00XX05-152	L-D Energy Saver Mekanik (220V)	136,04	30
	500-00XX25-136	L-D RFID Energy Saver 13.56 MHZ	2.394,30	1
	500-00XX25-201	L-D RFID Energy Saver Boş Modül	108,83	1
	500-00XX05-134	L-D Dimmer 800W	435,33	30
	500-00XX05-135	L-D Dimmer Filtreli 500W	870,66	30
	500-00XX05-147	L-D Veavien Dimmer 300W	870,66	30
	500-00XX05-179	L-D RC Dimmer 3W-250W LED	1.305,98	30
	500-00XX06-123	L-D Müzik Yayın Anahtarı	609,46	12
	500-00XX05-133	L-D Buzzer Zil	348,26	30
	210-010500-012	Energy Saver Röle VRV RFID 2x16A 13.56 MHZ	2.176,64	1
	210-000600-014	Energy Saver Röle VRV RFID 3x16A 13.56 MHZ	2.394,30	1
	210-000600-001	Energy Saver Röle 1x16A + 1x30A	2.285,47	1
	210-000600-004	Energy Saver Röle 2x16A	2.067,81	1
	500-00XX05-186	L-D Otel Uyarı Sistemi İç Ünite	124,70	1
	500-00XX05-187	L-D Otel Uyarı Sistemi Dış Ünite	304,73	1
	210-000600-002	Energy Saver Yan Çizgili Kart Optik	152,36	1
	210-000600-015	Energy Saver Kart RFID 13.56 MHZ	174,13	1
	210-000600-016	Energy Saver Kart-Optik Modüler	152,36	1
	210-000600-007	Kapı ve Pencere Switch	206,78	1
ÇERÇEVE GRUBU				
	103-XX0000-150	Larissa Kordon	2,16	100
	103-XX0000-153	Larissa İkili Kordon	4,32	70
	103-XX0000-160	Larissa Tekli Kordonsuz Çerçeve	10,16	180
	103-XX0000-161	Larissa İkili Kordonsuz Çerçeve	55,89	120
	103-XX0000-162	Larissa Üçlü Kordonsuz Çerçeve	89,62	140
	103-XX0000-163	Larissa Dörtlü Kordonsuz Çerçeve	94,38	80
	103-XX0000-164	Larissa Beşli Kordonsuz Çerçeve	124,19	80
	103-XX0000-165	Larissa İkili Priz Kordonsuz Çerçeve	48,87	120

DÜĞME RENK KODLARI

XX:01
BeyazXX:17
Krem

larissa
wood



Dinlendirici Tonlar





RUSTİK BİR GÖRÜNÜM - COUNTRY TARZI

LARISSA WOOD, iç dekorasyonda country tarzını ve rustik görünümü sevenler için tasarlandı. Doğal malzemeleri şık bir tasarımla harmanlamak için yaratıcı ve modern bir yol gösteren bu dekorasyon fikrini kullanabilirsiniz. Evinizi Meşe ve Kiraz'ın sıcak tonlarıyla tazeleyin, doğayı mekanınıza taşıyın.



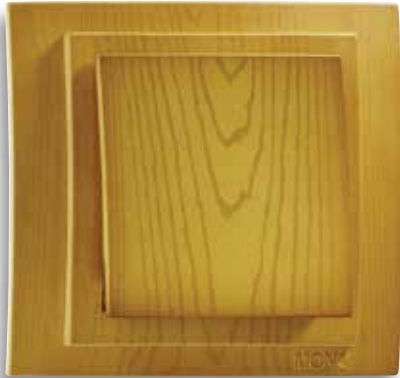

RENKLER



Meşe



Kiraz

GÖRSEL	VİDALI KOD	ÜRÜN ADI	FİYAT (TL)	KOLİ ADET
ANAHTAR GRUBU				
	500-00XX25-100	L-D Ahşap Anahtar	108,68	60
	500-00XX25-102	L-D Ahşap Komitatör	141,68	60
	500-00XX25-109	L-D Ahşap Veavien	151,63	60
	500-00XX25-112	L-D Ahşap Ara Veavien	242,44	60
	500-00XX23-111	L-D Ahşap Komitatör Veavien	213,79	60
	500-00XX22-114	L-D Ahşap Üçlü Anahtar	202,64	60
	500-00XX02-108	L-D Ahşap Üçlü Veavien	242,44	60
	500-00XX25-105	L-D Ahşap Light	113,28	60
	500-00XX25-107	L-D Ahşap Zil	113,28	60
	500-00XX25-129	L-D Ahşap Etiketli İsimli Zil	115,00	60
	500-00XX25-104	L-D Ahşap Kapı Otomatiği	113,28	60
	500-00XX25-172	L-D Ahşap Otomasyon Anahtarı	178,52	60
	500-00XX25-173	L-D Ahşap Otomasyon Komitatör Tek Faz	179,08	60
	500-00XX25-174	L-D Ahşap Otomasyon Komitatör Çift Faz	203,87	60
	500-00XX25-191	L-D Ahşap Üçlü Light	231,42	60
	500-00XX25-113	L-D Ahşap Jaluzi Kumanda	221,76	60
	500-00XX25-159	L-D Ahşap Jaluzi Kumanda Tek Tuşlu	214,37	60
	500-00XX06-115	L-D Ahşap Klima Anahtarı	330,60	60
500-00XX06-154	L-D Ahşap Isıtıcı Anahtarı	330,60	60	
İŞIKLI ANAHTAR GRUBU				
	500-00XX25-101	L-D Ahşap Işıklı Anahtar	198,36	60
	500-00XX25-103	L-D Ahşap Işıklı Komitatör	209,38	60
	500-00XX25-106	L-D Ahşap Işıklı Light	206,63	60
	500-00XX25-155	L-D Ahşap Işıklı Zil (220V)	206,63	60
	500-00XX25-110	L-D Ahşap Işıklı Veavien	209,66	60
PRİZ GRUBU				
	500-00XX22-116	L-D Ahşap Priz	146,70	60
	500-00XX21-117	L-D Ahşap Topraklı Priz	151,88	60
	500-00XX21-118	L-D Ahşap Kapaklı Topraklı Priz	189,54	60
	500-00XX21-119	L-D Ahşap Çocuk Korumalı Topraklı Priz	159,98	60
	500-00XX21-158	L-D Ahşap Kapaklı Çocuk Korumalı Topraklı Priz	194,40	60
	500-00XX23-122	L-D Ahşap UPS Priz	163,23	60
	500-00XX23-129	L-D Ahşap UPS Priz Çocuk Korumalı	167,37	60
	500-00XX05-121	L-D Ahşap İkili Priz	196,29	60
	500-00XX04-120	L-D Ahşap İkili Topraklı Priz	227,29	60
	500-00XX04-123	L-D Ahşap İkili Topraklı Priz Çocuk Korumalı	235,55	60
	103-XXXX04-120	Larissa Ahşap İkili Topraklı Priz (Komple)	434,01	50
103-XXXX04-123	Larissa Ahşap İkili Topraklı Priz Çocuk Korumalı (Komple)	441,49	50	
İLETİŞİM GRUBU				
	500-00XX05-124	L-D Ahşap Numeris Telefon Prizi (RJ11)	165,60	60
	500-00XX25-124	L-D Ahşap Numeris Telefon Prizi (Cat3 Model)	198,36	60
	500-00XX05-176	L-D Ahşap İkili Numeris (RJ11 + RJ11)	192,85	60
	500-00XX05-131	L-D Ahşap İkili Numeris Telefon Prizi (2 x Cat3)	297,54	60
	500-00XX05-125	L-D Ahşap Data Prizi (Cat6)	333,00	60
	500-00XX05-182	L-D Ahşap Data Prizi (Cat6) Toz Kapaklı	358,15	60
	500-00XX05-190	L-D Ahşap Data Prizi (Cat6A)	358,15	60
	500-00XX05-126	L-D Ahşap İkili Data Prizi (2 x Cat6)	421,52	60
	500-00XX05-183	L-D Ahşap İkili Data Prizi (2 x Cat6) Toz Kapaklı	436,39	60
	500-00XX05-202	L-D Ahşap İkili Data Prizi (2 x Cat6A)	436,39	60
	500-00XX05-132	L-D Ahşap Data + Numeris Telefon Prizi (Cat6 x Cat3)	319,58	60
	500-00XX05-184	L-D Ahşap Numeris Cat3+F Konnektör	242,44	60
	500-00XX05-185	L-D Ahşap Data Cat6+F Konnektör	330,60	60
	500-00XX05-130	L-D Ahşap F Konnektör Bağlantı Aparatı	202,24	60
	500-00XX05-137	L-D Ahşap TV Priz Ekran Geçişli Dişi	253,46	60
	500-00XX05-138	L-D Ahşap TV Priz Ekran Sonlu Dişi	253,46	60
	500-00XX05-170	L-D Ahşap TV Priz Ekranlı Geçişli Erkek	253,46	60
	500-00XX05-171	L-D Ahşap TV Priz Ekranlı Sonlu Erkek	253,46	60
	500-00XX05-148	L-D Ahşap Tekli Uydu Prizi Geçişli	297,54	60
	500-00XX05-149	L-D Ahşap Tekli Uydu Prizi Sonlu	297,54	60
	500-00XX05-139	L-D Ahşap TV + Sat - Geçişli	506,92	60

XX: 30 KIRAZ, 31 MEŞE

GÖRSEL	VİDALI KOD	ÜRÜN ADI	FİYAT (TL)	KOLİ ADET
İLETİŞİM GRUBU				
	500-00XX05-140	L-D Ahşap TV + Sat - Sonlu	506,92	60
	500-00XX07-146	L-D Ahşap TV-R-Sat Geçişli	584,06	60
	500-00XX05-142	L-D Ahşap 2'li Müzik Yayın Prizi	617,12	60
	500-00XX05-181	L-D Ahşap Audio Prizi	517,94	12
	500-00XX05-180	L-D Ahşap VGA Prizi	936,70	12
	500-00XX05-144	L-D Ahşap USB Data	286,52	12
	500-00XX05-145	L-D Ahşap HDMI Data	374,68	12
	500-00XX05-195	L-D Ahşap HDMI + USB Priz	454,58	12
	500-00XX05-197	L-D Ahşap Fiber Data Prizi (Mavi)	165,30	30
	YENİ 500-00XX05-203	L-D Ahşap USB + TYPE C Şarj Priz	793,44	30
	500-00XX05-150	L-D Ahşap Data Prizi (Soketsiz)	143,52	60
	500-00XX05-151	L-D Ahşap İkili Data Prizi (Soketsiz)	143,52	60
	500-00XX05-175	L-D Ahşap Kablo Çıkış Kapağı	143,52	60
ELEKTRONİK GRUBU				
	500-00XX05-136	L-D Ahşap Energy Saver Optik (24V)	683,24	1
	500-00XX05-152	L-D Ahşap Energy Saver Mekanik (220V)	179,08	30
	500-00XX25-136	L-D Ahşap RFID Energy Saver	2.644,80	1
	500-00XX25-201	L-D Ahşap RFID Energy Saver Boş Modül	143,26	1
	500-00XX05-134	L-D Ahşap Dimmer 800W	506,92	30
	500-00XX05-135	L-D Ahşap Dimmer Filtreli 500W	947,72	30
	500-00XX05-147	L-D Ahşap Veavien Dimmer 300W	947,72	30
	500-00XX05-179	L-D Ahşap RC Dimmer 3W-250W LED	1.388,52	30
	500-00XX06-123	L-D Ahşap Müzik Yayın Anahtarı	705,28	12
	500-00XX05-133	L-D Ahşap Buzzer Zil	391,21	30
	210-000600-012	Energy Saver Röle VRV RFID 2x16A 13.56 MHZ	2.204,00	1
	210-000600-014	Energy Saver Röle VRV RFID 3x16A 13.56 MHZ	2.424,40	1
	210-000600-001	Energy Saver Röle 1x16A + 1x30A	2.314,20	1
	210-000600-004	Energy Saver Röle 2x16A	2.093,80	1
	500-00XX05-186	L-D Ahşap Otel Uyarı Sistemi İç Ünite	198,36	1
	500-00XX05-187	L-D Ahşap Otel Uyarı Sistemi Dış Ünite	385,70	1
	210-000600-002	Energy Saver Yan Çizgili Kart Optik	154,28	1
	210-000600-015	Energy Saver Kart RFID 13.56 MHZ	176,32	1
	210-000600-016	Energy Saver Kart-Optik Modüler	154,28	1
	210-000600-007	Kapı ve Pencere Switch	209,38	1
ÇERÇEVE GRUBU				
	103-XX0000-160	Larissa Ahşap Tekli Çerçeve	73,92	130
	103-XX0000-161	Larissa Ahşap İkili Çerçeve	230,23	80
	103-XX0000-162	Larissa Ahşap Üçlü Çerçeve	234,08	85
	103-XX0000-163	Larissa Ahşap Dörtlü Çerçeve	252,08	40
	103-XX0000-164	Larissa Ahşap Beşli Çerçeve	274,32	40
	103-XX0000-165	Larissa Ahşap İkili Priz Çerçeve	205,94	40

DÜĞME RENK KODLARI

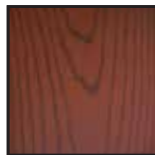

XX:30
Kiraz

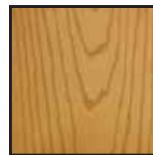

XX:31
Meşe

chrome

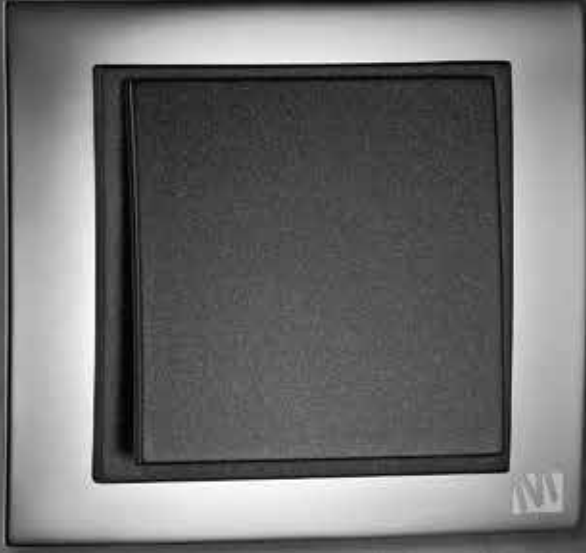

Fark
Yaratın





GÖRKEMLİ DOKUNSAL DENEYİM RENK VE FORMUN SİNERJİSİ

Şekil, renk ve malzeme sinerjisi getiren bir anahtar serisi. Maksimum performans ve zarif estetik CHROME'u oldukça işlevsel kılıyor. Esnek, teknik olarak yenilikçi ve mükemmellik için tasarlanmış CHROME, tüm yaşam alanları için ideal çözüm olmaya devam ediyor.

RENKLER



Gümüş







Füme



Bronz



Gold

GÖRSEL	VİDALI KOD	ÜRÜN ADI	FİYAT (TL)	KOLİ ADET
ANAHTAR GRUBU				
	500-00XX25-100	L-D Metalik Anahtar	102,35	60
	500-00XX25-102	L-D Metalik Komitatör	138,24	60
	500-00XX25-109	L-D Metalik Veavien	139,97	60
	500-00XX25-112	L-D Metalik Ara Veavien	231,42	60
	500-00XX23-111	L-D Metalik Komitatör Veavien	202,77	60
	500-00XX22-114	L-D Metalik Üçlü Anahtar	190,72	60
	500-00XX02-108	L-D Metalik Üçlü Veavien	231,42	60
	500-00XX25-105	L-D Metalik Light	116,25	60
	500-00XX25-107	L-D Metalik Zil	116,25	60
	500-00XX25-129	L-D Metalik Etiketli İsimli Zil	117,50	60
	500-00XX25-104	L-D Metalik Kapı Otomatığı	116,25	60
	500-00XX25-172	L-D Metalik Otomasyon Anahtarı	168,61	60
	500-00XX25-173	L-D Metalik Otomasyon Komitatör Tek Faz	179,08	60
	500-00XX25-174	L-D Metalik Otomasyon Komitatör Çift Faz	192,85	60
	500-00XX25-191	L-D Metalik Üçlü Light	218,20	60
	500-00XX25-113	L-D Metalik Jaluzi Kumanda	209,44	60
	500-00XX25-159	L-D Metalik Jaluzi Kumanda Tek Tuşlu	197,12	60
500-00XX06-115	L-D Metalik Klima Anahtarı	319,58	60	
500-00XX06-154	L-D Metalik Isıtıcı Anahtarı	319,58	60	
IŞIKLI ANAHTAR GRUBU				
	500-00XX25-101	L-D Metalik Işıklı Anahtar	187,34	60
	500-00XX25-103	L-D Metalik Işıklı Komitatör	198,36	60
	500-00XX25-106	L-D Metalik Işıklı Light	192,85	60
	500-00XX25-155	L-D Metalik Işıklı Zil (220V)	192,85	60
	500-00XX25-110	L-D Metalik Işıklı Veavien	200,56	60
PRİZ GRUBU				
	500-00XX22-116	L-D Metalik Priz	136,37	60
	500-00XX21-117	L-D Metalik Topraklı Priz	141,75	60
	500-00XX21-118	L-D Metalik Kapaklı Topraklı Priz	177,39	60
	500-00XX21-119	L-D Metalik Çocuk Korumalı Topraklı Priz	149,85	60
	500-00XX21-158	L-D Metalik Kapaklı Çocuk Korumalı Topraklı Priz	182,25	60
	500-00XX23-122	L-D Metalik UPS Priz	152,90	60
	500-00XX23-129	L-D Metalik UPS Priz Çocuk Korumalı	157,04	60
İLETİŞİM GRUBU				
	500-00XX05-124	L-D Metalik Numeris Telefon Prizi (RJ11)	150,14	60
	500-00XX25-124	L-D Metalik Numeris Telefon Prizi (Cat3 Model)	187,36	60
	500-00XX05-176	L-D Metalik İkili Numeris (RJ11 + RJ11)	176,32	60
	500-00XX05-131	L-D Metalik İkili Numeris Telefon Prizi (2 x Cat3)	286,52	60
	500-00XX05-125	L-D Metalik Data Prizi (Cat6)	319,68	60
	500-00XX05-182	L-D Metalik Data Prizi (Cat6) Toz Kapaklı	340,24	60
	500-00XX05-190	L-D Metalik Data Prizi (Cat6A)	340,24	60
	500-00XX05-126	L-D Metalik İkili Data Prizi (2 x Cat6)	409,12	60
	500-00XX05-183	L-D Metalik İkili Data Prizi (2 x Cat6) Toz Kapaklı	412,15	60
	500-00XX05-202	L-D Metalik İkili Data Prizi (2 x Cat6A)	412,15	60
	500-00XX05-132	L-D Metalik Data + Numeris Telefon Prizi (Cat6 x Cat3)	308,56	60
	500-00XX05-184	L-D Metalik Numeris Cat3+F Konnektör	223,16	60
	500-00XX05-185	L-D Metalik Data Cat6+F Konnektör	308,56	60
	500-00XX05-130	L-D Metalik F Konnektör Bağlantı Aparatı	176,64	60
	500-00XX05-127	L-D Metalik TV Priz Sonlu Dişi F Konn Bağlantılı	165,30	60
	500-00XX05-137	L-D Metalik TV Priz Ekran Geçişli Dişi	242,44	60
	500-00XX05-138	L-D Metalik TV Priz Ekran Sonlu Dişi	242,44	60
	500-00XX05-170	L-D Metalik TV Priz Ekranlı Geçişli Erkek	242,44	60
	500-00XX05-171	L-D Metalik TV Priz Ekranlı Sonlu Erkek	242,44	60
	500-00XX05-148	L-D Metalik Tekli Uydu Prizi Geçişli	275,50	60
	500-00XX05-149	L-D Metalik Tekli Uydu Prizi Sonlu	275,50	60
	500-00XX05-139	L-D Metalik TV + Sat - Geçişli	484,88	60
	500-00XX05-140	L-D Metalik TV + Sat - Sonlu	484,88	60
	500-00XX07-146	L-D Metalik TV-R-Sat Geçişli	573,04	60
	500-00XX05-142	L-D Metalik 2'li Müzik Yayın Prizi	595,08	60
	500-00XX05-181	L-D Metalik Audio Prizi	495,90	12
	500-00XX05-180	L-D Metalik VGA Prizi	914,66	12
500-00XX05-144	L-D Metalik USB Data	264,48	12	

XX: 20 FÜME, 21 GÜMÜŞ, 22 TİTANYUM, 23 AÇIK FÜME, 24 ANTRASİT

GÖRSEL	VİDALI KOD	ÜRÜN ADI	FİYAT (TL)	KOLİ ADET
İLETİŞİM GRUBU				
	500-00XX05-145	L-D Metalik HDMI Data	352,64	12
	500-00XX05-195	L-D Metalik HDMI +USB Priz	440,80	12
	500-00XX05-197	L-D Metalik Fiber Data Prizi (Mavi)	154,28	30
	500-00XX05-203	L-D Metalik USB + TYPE C Şarj Priz	771,40	30
	500-00XX05-150	L-D Metalik Data Prizi (Soketsiz)	123,65	60
	500-00XX05-151	L-D Metalik İkili Data Prizi (Soketsiz)	123,65	60
	500-00XX05-175	L-D Metalik Kablo Çıkış Kapağı	123,65	60
ELEKTRONİK GRUBU				
	500-00XX05-136	L-D Metalik Energy Saver Optik (24V)	661,20	1
	500-00XX05-152	L-D Metalik Energy Saver Mekanik (220V)	151,53	30
	500-00XX05-134	L-D Metalik Dimmer 800W	484,88	30
	500-00XX05-135	L-D Metalik Dimmer Filtreli 500W	925,68	30
	500-00XX05-147	L-D Metalik Veavien Dimmer 300W	925,68	30
	500-00XX05-179	L-D Metalik RC Dimmer 3W-250W LED	1.366,48	30
	500-00XX06-123	L-D Metalik Müzik Yayın Anahtarı	661,20	12
	500-00XX05-133	L-D Metalik Buzzer Zil	371,93	30
	210-000600-012	Energy Saver Röle VRV RFID 2x16A 13.56 MHZ	2.204,00	1
	210-000600-014	Energy Saver Röle VRV RFID 3x16A 13.56 MHZ	2.424,40	1
	210-000600-001	Energy Saver Röle 1x16A + 1x30A	2.314,20	1
	210-000600-004	Energy Saver Röle 2x16A	2.093,80	1
	500-00XX05-186	L-D Metalik Otel Uyarı Sistemi İç Ünite	165,30	1
	500-00XX05-187	L-D Metalik Otel Uyarı Sistemi Dış Ünite	352,64	1
	210-000600-002	Energy Saver Yan Çizgili Kart Optik	154,28	1
	210-000600-015	Energy Saver Kart RFID 13.56 MHZ	176,32	1
	210-000600-016	Energy Saver Kart-Optik Modüler	154,28	1
210-000600-007	Kapı ve Pencere Switch	209,38	1	
KROM ÇERÇEVE GRUBU				
	106-410000-160	Chrome Krom Tekli Çerçeve	417,60	5
	106-410000-161	Chrome Krom İkili Çerçeve	696,00	5
	106-410000-162	Chrome Krom Üçlü Çerçeve	928,00	5
	106-410000-163	Chrome Krom Dörtlü Çerçeve	1.392,00	5
FÜME ÇERÇEVE GRUBU				
	106-420000-160	Chrome Füme Tekli Çerçeve	533,60	5
	106-420000-161	Chrome Füme İkili Çerçeve	881,60	5
	106-420000-162	Chrome Füme Üçlü Çerçeve	1.252,80	5
	106-420000-163	Chrome Füme Dörtlü Çerçeve	1.809,60	5
BRONZ ÇERÇEVE GRUBU				
	106-430000-160	Chrome Bronz Tekli Çerçeve	533,60	5
	106-430000-161	Chrome Bronz İkili Çerçeve	881,60	5
	106-430000-162	Chrome Bronz Üçlü Çerçeve	1.252,80	5
	106-430000-163	Chrome Bronz Dörtlü Çerçeve	1.809,60	5
GOLD ÇERÇEVE GRUBU				
	106-440000-160	Chrome Gold Tekli Çerçeve	533,60	5
	106-440000-161	Chrome Gold İkili Çerçeve	881,60	5
	106-440000-162	Chrome Gold Üçlü Çerçeve	1.252,80	5
	106-440000-163	Chrome Gold Dörtlü Çerçeve	1.809,60	5

DÜĞME RENK KODLARI



XX:20
Füme



XX:21
Gümüş



XX:22
Titanium



XX:23
Açık Füme



XX:24
Antrasit

Style

aluminium



İlham Veren
Ritim ve
Enerji





MÜKEMMEL DAYANIKLILIK YÜKSEK ÇİZİLME DİRENCİ

Bu ürünün eşsiz ve özel olmasını sağlayan renk, biçim ve malzeme seçimidir. STYLE ALUMINIUM tasarımında kullanılan metaryaller ve renkleri mekanınızda uzun süreli bir uyum yaratmaya katkıda bulunur. Gümüş, Füme, Bronz ve Titanyum seçenekleri ile 4 renkten oluşan şık bir renk aralığı sunar.

RENKLER



Gümüş







Füme









Bronz



Titanyum

GÖRSEL	VİDALI KOD	ÜRÜN ADI	FİYAT (TL)	KOLİ ADET
ANAHTAR GRUBU				
	500-00XX25-100	L-D Metalik Anahtar	102,35	60
	500-00XX25-102	L-D Metalik Komitatör	138,24	60
	500-00XX25-109	L-D Metalik Veavien	139,97	60
	500-00XX25-112	L-D Metalik Ara Veavien	231,42	60
	500-00XX23-111	L-D Metalik Komitatör Veavien	202,77	60
	500-00XX22-114	L-D Metalik Üçlü Anahtar	190,72	60
	500-00XX02-108	L-D Metalik Üçlü Veavien	231,42	60
	500-00XX25-105	L-D Metalik Light	116,25	60
	500-00XX25-107	L-D Metalik Zil	116,25	60
	500-00XX25-129	L-D Metalik Etiketli İsimli Zil	117,50	60
	500-00XX25-104	L-D Metalik Kapı Otomatığı	116,25	60
	500-00XX25-172	L-D Metalik Otomasyon Anahtarı	168,61	60
	500-00XX25-173	L-D Metalik Otomasyon Komitatör Tek Faz	179,08	60
	500-00XX25-174	L-D Metalik Otomasyon Komitatör Çift Faz	192,85	60
	500-00XX25-191	L-D Metalik Üçlü Light	218,20	60
	500-00XX25-113	L-D Metalik Jaluzi Kumanda	209,44	60
	500-00XX25-159	L-D Metalik Jaluzi Kumanda Tek Tuşlu	197,12	60
500-00XX06-115	L-D Metalik Klima Anahtarı	319,58	60	
500-00XX06-154	L-D Metalik Isıtıcı Anahtarı	319,58	60	
IŞIKLI ANAHTAR GRUBU				
	500-00XX25-101	L-D Metalik Işıklı Anahtar	187,34	60
	500-00XX25-103	L-D Metalik Işıklı Komitatör	198,36	60
	500-00XX25-106	L-D Metalik Işıklı Light	192,85	60
	500-00XX25-155	L-D Metalik Işıklı Zil (220V)	192,85	60
	500-00XX25-110	L-D Metalik Işıklı Veavien	200,56	60
PRİZ GRUBU				
	500-00XX22-116	L-D Metalik Priz	136,37	60
	500-00XX21-117	L-D Metalik Topraklı Priz	141,75	60
	500-00XX21-118	L-D Metalik Kapaklı Topraklı Priz	177,39	60
	500-00XX21-119	L-D Metalik Çocuk Korumalı Topraklı Priz	149,85	60
	500-00XX21-158	L-D Metalik Kapaklı Çocuk Korumalı Topraklı Priz	182,25	60
	500-00XX23-122	L-D Metalik UPS Priz	152,90	60
	500-00XX23-129	L-D Metalik UPS Priz Çocuk Korumalı	157,04	60
İLETİŞİM GRUBU				
	500-00XX05-124	L-D Metalik Numeris Telefon Prizi (RJ11)	150,14	60
	500-00XX25-124	L-D Metalik Numeris Telefon Prizi (Cat3 Model)	187,36	60
	500-00XX05-176	L-D Metalik İkili Numeris (RJ11 + RJ11)	176,32	60
	500-00XX05-131	L-D Metalik İkili Numeris Telefon Prizi (2 x Cat3)	286,52	60
	500-00XX05-125	L-D Metalik Data Prizi (Cat6)	319,68	60
	500-00XX05-182	L-D Metalik Data Prizi (Cat6) Toz Kapaklı	340,24	60
	500-00XX05-190	L-D Metalik Data Prizi (Cat6A)	340,24	60
	500-00XX05-126	L-D Metalik İkili Data Prizi (2 x Cat6)	409,12	60
	500-00XX05-183	L-D Metalik İkili Data Prizi (2 x Cat6) Toz Kapaklı	412,15	60
	500-00XX05-202	L-D Metalik İkili Data Prizi (2 x Cat6A)	412,15	60
	500-00XX05-132	L-D Metalik Data + Numeris Telefon Prizi (Cat6 x Cat3)	308,56	60
	500-00XX05-184	L-D Metalik Numeris Cat3+F Konnektör	223,16	60
	500-00XX05-185	L-D Metalik Data Cat6+F Konnektör	308,56	60
	500-00XX05-130	L-D Metalik F Konnektör Bağlantı Aparatı	176,64	60
	500-00XX05-127	L-D Metalik TV Priz Sonlu Dişi F Konn Bağlantılı	165,30	60
	500-00XX05-137	L-D Metalik TV Priz Ekran Geçişli Dişi	242,44	60
	500-00XX05-138	L-D Metalik TV Priz Ekran Sonlu Dişi	242,44	60
	500-00XX05-170	L-D Metalik TV Priz Ekranlı Geçişli Erkek	242,44	60
	500-00XX05-171	L-D Metalik TV Priz Ekranlı Sonlu Erkek	242,44	60
	500-00XX05-148	L-D Metalik Tekli Uydu Prizi Geçişli	275,50	60
	500-00XX05-149	L-D Metalik Tekli Uydu Prizi Sonlu	275,50	60
	500-00XX05-139	L-D Metalik TV + Sat - Geçişli	484,88	60
	500-00XX05-140	L-D Metalik TV + Sat - Sonlu	484,88	60
	500-00XX07-146	L-D Metalik TV-R-Sat Geçişli	573,04	60
	500-00XX05-142	L-D Metalik 2'li Müzik Yayın Prizi	595,08	60
	500-00XX05-181	L-D Metalik Audio Prizi	495,90	12
	500-00XX05-180	L-D Metalik VGA Prizi	914,66	12
	500-00XX05-144	L-D Metalik USB Data	264,48	12

XX: 20 FÜME, 21 GÜMÜŞ, 22 TİTANYUM, 23 AÇIK FÜME, 24 ANTRASİT

GÖRSEL	VİDALI KOD	ÜRÜN ADI	FİYAT (TL)	KOLİ ADET
İLETİŞİM GRUBU				
	500-00XX05-145	L-D Metalik HDMI Data	352,64	12
	500-00XX05-195	L-D Metalik HDMI +USB Priz	440,80	12
	500-00XX05-197	L-D Metalik Fiber Data Prizi (Mavi)	154,28	30
	500-00XX05-203	L-D Metalik USB + TYPE C Şarj Priz	771,40	30
	500-00XX05-150	L-D Metalik Data Prizi (Soketsiz)	123,65	60
	500-00XX05-151	L-D Metalik İkili Data Prizi (Soketsiz)	123,65	60
	500-00XX05-175	L-D Metalik Kablo Çıkış Kapağı	123,65	60
ELEKTRONİK GRUBU				
	500-00XX05-136	L-D Metalik Energy Saver Optik (24V)	661,20	1
	500-00XX05-152	L-D Metalik Energy Saver Mekanik (220V)	151,53	30
	500-00XX25-136	L-D Metalik RFID Energy Saver	2.534,60	1
	500-00XX25-201	L-D Metalik RFID Energy Saver Boş Modül	132,24	1
	500-00XX05-134	L-D Metalik Dimmer 800W	484,88	30
	500-00XX05-135	L-D Metalik Dimmer Filtreli 500W	925,68	30
	500-00XX05-147	L-D Metalik Veavien Dimmer 300W	925,68	30
	500-00XX05-179	L-D Metalik RC Dimmer 3W-250W LED	1.366,48	30
	500-00XX06-123	L-D Metalik Müzik Yayın Anahtarı	661,20	12
	500-00XX05-133	L-D Metalik Buzzer Zil	371,93	30
	210-000600-012	Energy Saver Röle VRV RFID 2x16A 13.56 MHZ	2.204,00	1
	210-000600-014	Energy Saver Röle VRV RFID 3x16A 13.56 MHZ	2.424,40	1
	210-000600-001	Energy Saver Röle 1x16A + 1x30A	2.314,20	1
	210-000600-004	Energy Saver Röle 2x16A	2.093,80	1
	500-00XX05-186	L-D Metalik Otel Uyarı Sistemi İç Ünite	165,30	1
	500-00XX05-187	L-D Metalik Otel Uyarı Sistemi Dış Ünite	352,64	1
	210-000600-002	Energy Saver Yan Çizgili Kart Optik	154,28	1
210-000600-015	Energy Saver Kart RFID 13.56 MHZ	176,32	1	
210-000600-016	Energy Saver Kart-Optik Modüler	154,28	1	
210-000600-007	Kapı ve Pencere Switch	209,38	1	
GÜMÜŞ ÇERÇEVE GRUBU				
	107-800000-160	Style Aluminium Gümüş Tekli Çerçeve	440,80	5
	107-800000-161	Style Aluminium Gümüş İkili Çerçeve	672,80	5
	107-800000-162	Style Aluminium Gümüş Üçlü Çerçeve	881,60	5
	107-800000-163	Style Aluminium Gümüş Dörtlü Çerçeve	1.113,60	5
	107-800000-164	Style Aluminium Gümüş Beşli Çerçeve	1.345,60	5
BRONZ ÇERÇEVE GRUBU				
	107-810000-160	Style Aluminium Bronz Tekli Çerçeve	440,80	5
	107-810000-161	Style Aluminium Bronz İkili Çerçeve	672,80	5
	107-810000-162	Style Aluminium Bronz Üçlü Çerçeve	881,60	5
	107-810000-163	Style Aluminium Bronz Dörtlü Çerçeve	1.113,60	5
	107-810000-164	Style Aluminium Bronz Beşli Çerçeve	1.345,60	5
FÜME ÇERÇEVE GRUBU				
	107-820000-160	Style Aluminium Füme Tekli Çerçeve	440,80	5
	107-820000-161	Style Aluminium Füme İkili Çerçeve	672,80	5
	107-820000-162	Style Aluminium Füme Üçlü Çerçeve	881,60	5
	107-820000-163	Style Aluminium Füme Dörtlü Çerçeve	1.113,60	5
	107-820000-164	Style Aluminium Füme Beşli Çerçeve	1.345,60	5
ŞAMPANYA ÇERÇEVE GRUBU				
	107-830000-160	Style Aluminium Şampanya Tekli Çerçeve	440,80	5
	107-830000-161	Style Aluminium Şampanya İkili Çerçeve	672,80	5
	107-830000-162	Style Aluminium Şampanya Üçlü Çerçeve	881,60	5
	107-830000-163	Style Aluminium Şampanya Dörtlü Çerçeve	1.113,60	5
	107-830000-164	Style Aluminium Şampanya Beşli Çerçeve	1.345,60	5

DÜĞME RENK KODLARI



XX:20
Füme



XX:21
Gümüş



XX:22
Titanium



XX:23
Açık Füme



XX:24
Antrasit

Style
glass



Lüksün
Teknoloji ile
Birleştiği
Tasarım





YÜKSEK MUKAVEMET - YÜKSEK ÇİZİLME DİRENCİ

Kare hatlarıyla, stili olan her alanla sorunsuz bir şekilde bütünleşen STYLE GLASS'ın tasarımında lüks teknolojiyle birleşiyor. Cam, değerinin kanıtlanmasına ihtiyaç duyulmayan bir malzemedir; sayısız özelliği, onu zarif bir dekorasyon için vazgeçilmez materyallerden biri haline getirir. Beyazın saflığı, siyahın zerafeti ve aynanın etkileyici görünüşü 9 büyüleyici renkteki düğme seçeneği ile tamamlanıyor.

RENKLER





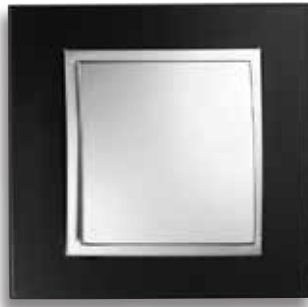

Beyaz







Siyah



Ayna

GÖRSEL	VİDALI KOD	ÜRÜN ADI	FİYAT (TL)	KOLİ ADET
ANAHTAR GRUBU				
	500-00XX25-100	L-D Metalik Anahtar	102,35	60
	500-00XX25-102	L-D Metalik Komitatör	138,24	60
	500-00XX25-109	L-D Metalik Veavien	139,97	60
	500-00XX25-112	L-D Metalik Ara Veavien	231,42	60
	500-00XX23-111	L-D Metalik Komitatör Veavien	202,77	60
	500-00XX22-114	L-D Metalik Üçlü Anahtar	190,72	60
	500-00XX02-108	L-D Metalik Üçlü Veavien	231,42	60
	500-00XX25-105	L-D Metalik Light	116,25	60
	500-00XX25-107	L-D Metalik Zil	116,25	60
	500-00XX25-129	L-D Metalik Etiketli İsimli Zil	117,50	60
	500-00XX25-104	L-D Metalik Kapı Otomatığı	116,25	60
	500-00XX25-172	L-D Metalik Otomasyon Anahtarı	168,61	60
	500-00XX25-173	L-D Metalik Otomasyon Komitatör Tek Faz	179,08	60
	500-00XX25-174	L-D Metalik Otomasyon Komitatör Çift Faz	192,85	60
	500-00XX25-191	L-D Metalik Üçlü Light	218,20	60
	500-00XX25-113	L-D Metalik Jaluzi Kumanda	209,44	60
	500-00XX25-159	L-D Metalik Jaluzi Kumanda Tek Tuşlu	197,12	60
500-00XX06-115	L-D Metalik Klima Anahtarı	319,58	60	
500-00XX06-154	L-D Metalik Isıtıcı Anahtarı	319,58	60	
IŞIKLI ANAHTAR GRUBU				
	500-00XX25-101	L-D Metalik Işıklı Anahtar	187,34	60
	500-00XX25-103	L-D Metalik Işıklı Komitatör	198,36	60
	500-00XX25-106	L-D Metalik Işıklı Light	192,85	60
	500-00XX25-155	L-D Metalik Işıklı Zil (220V)	192,85	60
	500-00XX25-110	L-D Metalik Işıklı Veavien	200,56	60
PRİZ GRUBU				
	500-00XX22-116	L-D Metalik Priz	136,37	60
	500-00XX21-117	L-D Metalik Topraklı Priz	141,75	60
	500-00XX21-118	L-D Metalik Kapaklı Topraklı Priz	177,39	60
	500-00XX21-119	L-D Metalik Çocuk Korumalı Topraklı Priz	149,85	60
	500-00XX21-158	L-D Metalik Kapaklı Çocuk Korumalı Topraklı Priz	182,25	60
	500-00XX23-122	L-D Metalik UPS Priz	152,90	60
	500-00XX23-129	L-D Metalik UPS Priz Çocuk Korumalı	157,04	60
İLETİŞİM GRUBU				
	500-00XX05-124	L-D Metalik Numeris Telefon Prizi (RJ11)	150,14	60
	500-00XX25-124	L-D Metalik Numeris Telefon Prizi (Cat3 Model)	187,36	60
	500-00XX05-176	L-D Metalik İkili Numeris (RJ11 + RJ11)	176,32	60
	500-00XX05-131	L-D Metalik İkili Numeris Telefon Prizi (2 x Cat3)	286,52	60
	500-00XX05-125	L-D Metalik Data Prizi (Cat6)	319,68	60
	500-00XX05-182	L-D Metalik Data Prizi (Cat6) Toz Kapaklı	340,24	60
	500-00XX05-190	L-D Metalik Data Prizi (Cat6A)	340,24	60
	500-00XX05-126	L-D Metalik İkili Data Prizi (2 x Cat6)	409,12	60
	500-00XX05-183	L-D Metalik İkili Data Prizi (2 x Cat6) Toz Kapaklı	412,15	60
	500-00XX05-202	L-D Metalik İkili Data Prizi (2 x Cat6A)	412,15	60
	500-00XX05-132	L-D Metalik Data + Numeris Telefon Prizi (Cat6 x Cat3)	308,56	60
	500-00XX05-184	L-D Metalik Numeris Cat3+F Konnektör	223,16	60
	500-00XX05-185	L-D Metalik Data Cat6+F Konnektör	308,56	60
	500-00XX05-130	L-D Metalik F Konnektör Bağlantı Aparatı	176,64	60
	500-00XX05-127	L-D Metalik TV Priz Sonlu Dişi F Konn Bağlantılı	165,30	60
	500-00XX05-137	L-D Metalik TV Priz Ekran Geçişli Dişi	242,44	60
	500-00XX05-138	L-D Metalik TV Priz Ekran Sonlu Dişi	242,44	60
	500-00XX05-170	L-D Metalik TV Priz Ekranlı Geçişli Erkek	242,44	60
	500-00XX05-171	L-D Metalik TV Priz Ekranlı Sonlu Erkek	242,44	60
	500-00XX05-148	L-D Metalik Tekli Uydu Prizi Geçişli	275,50	60
	500-00XX05-149	L-D Metalik Tekli Uydu Prizi Sonlu	275,50	60
	500-00XX05-139	L-D Metalik TV + Sat - Geçişli	484,88	60
	500-00XX05-140	L-D Metalik TV + Sat - Sonlu	484,88	60
	500-00XX07-146	L-D Metalik TV-R-Sat Geçişli	573,04	60
	500-00XX05-142	L-D Metalik 2'li Müzik Yayın Prizi	595,08	60
	500-00XX05-181	L-D Metalik Audio Prizi	495,90	12
	500-00XX05-180	L-D Metalik VGA Prizi	914,66	12
500-00XX05-144	L-D Metalik USB Data	264,48	12	

XX: 20 FÜME, 21 GÜMÜŞ, 22 TİTANYUM, 23 AÇIK FÜME, 24 ANTRASİT

GÖRSEL	VİDALI KOD	ÜRÜN ADI	FİYAT (TL)	KOLİ ADET
İLETİŞİM GRUBU				
	500-00XX05-145	L-D Metalik HDMI Data	352,64	12
	500-00XX05-195	L-D Metalik HDMI +USB Priz	440,80	12
	500-00XX05-197	L-D Metalik Fiber Data Prizi (Mavi)	154,28	30
	500-00XX05-203	L-D Metalik USB + TYPE C Şarj Priz	771,40	30
	500-00XX05-150	L-D Metalik Data Prizi (Soketsiz)	123,65	60
	500-00XX05-151	L-D Metalik İkili Data Prizi (Soketsiz)	123,65	60
	500-00XX05-175	L-D Metalik Kablo Çıkış Kapağı	123,65	60
ELEKTRONİK GRUBU				
	500-00XX05-136	L-D Metalik Energy Saver Optık (24V)	661,20	1
	500-00XX05-152	L-D Metalik Energy Saver Mekanik (220V)	151,53	30
	500-00XX25-136	L-D Metalik RFID Energy Saver	2.534,60	1
	500-00XX25-201	L-D Metalik RFID Energy Saver Boş Modül	132,24	1
	500-00XX05-134	L-D Metalik Dimmer 800W	484,88	30
	500-00XX05-135	L-D Metalik Dimmer Filtreli 500W	925,68	30
	500-00XX05-147	L-D Metalik Veavien Dimmer 300W	925,68	30
	500-00XX05-179	L-D Metalik RC Dimmer 3W-250W LED	1.366,48	30
	500-00XX06-123	L-D Metalik Müzik Yayın Anahtarı	661,20	12
	500-00XX05-133	L-D Metalik Buzzer Zil	371,93	30
	210-000600-012	Energy Saver Röle VRV RFID 2x16A 13.56 MHZ	2.204,00	1
	210-000600-014	Energy Saver Röle VRV RFID 3x16A 13.56 MHZ	2.424,40	1
	210-000600-001	Energy Saver Röle 1x16A + 1x30A	2.314,20	1
	210-000600-004	Energy Saver Röle 2x16A	2.093,80	1
	500-00XX05-186	L-D Metalik Otel Uyarı Sistemi İç Ünite	165,30	1
	500-00XX05-187	L-D Metalik Otel Uyarı Sistemi Dış Ünite	352,64	1
	210-000600-002	Energy Saver Yan Çizgili Kart Optık	154,28	1
	210-000600-015	Energy Saver Kart RFID 13.56 MHZ	176,32	1
	210-000600-016	Energy Saver Kart-Optık Modüler	154,28	1
	210-000600-007	Kapı ve Pencere Switch	209,38	1
BEYAZ ÇERÇEVE GRUBU				
	107-710000-160	Style Glass Beyaz Tekli Çerçeve	1.044,00	5
	107-710000-161	Style Glass Beyaz İkili Çerçeve	1.554,40	5
	107-710000-162	Style Glass Beyaz Üçlü Çerçeve	1.879,20	5
	107-710000-163	Style Glass Beyaz Dörtlü Çerçeve	2.320,00	5
	107-710000-164	Style Glass Beyaz Beşli Çerçeve	2.668,00	5
SİYAH ÇERÇEVE GRUBU				
	107-720000-160	Style Glass Siyah Tekli Çerçeve	1.044,00	5
	107-720000-161	Style Glass Siyah İkili Çerçeve	1.554,40	5
	107-720000-162	Style Glass Siyah Üçlü Çerçeve	1.879,20	5
	107-720000-163	Style Glass Siyah Dörtlü Çerçeve	2.320,00	5
	107-720000-164	Style Glass Siyah Beşli Çerçeve	2.668,00	5
AYNA ÇERÇEVE GRUBU				
	107-700000-160	Style Glass Aynalı Tekli Çerçeve	1.044,00	5
	107-700000-161	Style Glass Aynalı İkili Çerçeve	1.554,40	5
	107-700000-162	Style Glass Aynalı Üçlü Çerçeve	1.879,20	5
	107-700000-163	Style Glass Aynalı Dörtlü Çerçeve	2.320,00	5
	107-700000-164	Style Glass Aynalı Beşli Çerçeve	2.668,00	5

DÜĞME RENK KODLARI



XX:20
Füme



XX:21
Gümüş



XX:22
Titanium



XX:23
Açık Füme



XX:24
Antrasit

Style
plexy



Yeni Stil
Arayanlara,
Yeni Seri





ESTETİK VE YÜKSEK DAYANIKLILIK

Köşeli ve modern çizgisiyle, her alanda size yeni bir sitil alternatifi sunan STYLE PLEXY yüksek teknoloji ve estetiği bir arada sunuyor. Lüks ve yeni nesil bir estetik metaryel olan pleksi, konfor alanlarınız için modern duruşu ile yeni bir dekorasyon metaryel seçeneği. 3 büyüleyici renkten oluşan çerçeve seçeneği ile bir arada.

RENKLER





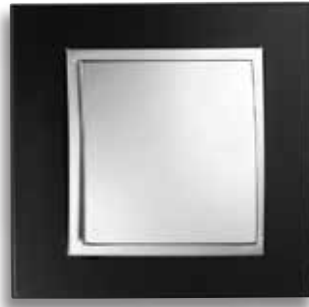

Beyaz







Siyah



Gold

GÖRSEL	VİDALI KOD	ÜRÜN ADI	FİYAT (TL)	KOLİ ADET
ANAHTAR GRUBU				
	500-00XX25-100	L-D Metalik Anahtar	102,35	60
	500-00XX25-102	L-D Metalik Komitatör	138,24	60
	500-00XX25-109	L-D Metalik Veavien	139,97	60
	500-00XX25-112	L-D Metalik Ara Veavien	231,42	60
	500-00XX23-111	L-D Metalik Komitatör Veavien	202,77	60
	500-00XX22-114	L-D Metalik Üçlü Anahtar	190,72	60
	500-00XX02-108	L-D Metalik Üçlü Veavien	231,42	60
	500-00XX25-105	L-D Metalik Light	116,25	60
	500-00XX25-107	L-D Metalik Zil	116,25	60
	500-00XX25-129	L-D Metalik Etiketli İsimli Zil	117,50	60
	500-00XX25-104	L-D Metalik Kapı Otomatığı	116,25	60
	500-00XX25-172	L-D Metalik Otomasyon Anahtarı	168,61	60
	500-00XX25-173	L-D Metalik Otomasyon Komitatör Tek Faz	179,08	60
	500-00XX25-174	L-D Metalik Otomasyon Komitatör Çift Faz	192,85	60
	500-00XX25-191	L-D Metalik Üçlü Light	218,20	60
	500-00XX25-113	L-D Metalik Jaluzi Kumanda	209,44	60
	500-00XX25-159	L-D Metalik Jaluzi Kumanda Tek Tuşlu	197,12	60
500-00XX06-115	L-D Metalik Klima Anahtarı	319,58	60	
500-00XX06-154	L-D Metalik Isıtıcı Anahtarı	319,58	60	
IŞIKLI ANAHTAR GRUBU				
	500-00XX25-101	L-D Metalik Işıklı Anahtar	187,34	60
	500-00XX25-103	L-D Metalik Işıklı Komitatör	198,36	60
	500-00XX25-106	L-D Metalik Işıklı Light	192,85	60
	500-00XX25-155	L-D Metalik Işıklı Zil (220V)	192,85	60
	500-00XX25-110	L-D Metalik Işıklı Veavien	200,56	60
PRİZ GRUBU				
	500-00XX22-116	L-D Metalik Priz	136,37	60
	500-00XX21-117	L-D Metalik Topraklı Priz	141,75	60
	500-00XX21-118	L-D Metalik Kapaklı Topraklı Priz	177,39	60
	500-00XX21-119	L-D Metalik Çocuk Korumalı Topraklı Priz	149,85	60
	500-00XX21-158	L-D Metalik Kapaklı Çocuk Korumalı Topraklı Priz	182,25	60
	500-00XX23-122	L-D Metalik UPS Priz	152,90	60
	500-00XX23-129	L-D Metalik UPS Priz Çocuk Korumalı	157,04	60
İLETİŞİM GRUBU				
	500-00XX05-124	L-D Metalik Numeris Telefon Prizi (RJ11)	150,14	60
	500-00XX25-124	L-D Metalik Numeris Telefon Prizi (Cat3 Model)	187,36	60
	500-00XX05-176	L-D Metalik İkili Numeris (RJ11 + RJ11)	176,32	60
	500-00XX05-131	L-D Metalik İkili Numeris Telefon Prizi (2 x Cat3)	286,52	60
	500-00XX05-125	L-D Metalik Data Prizi (Cat6)	319,68	60
	500-00XX05-182	L-D Metalik Data Prizi (Cat6) Toz Kapaklı	340,24	60
	500-00XX05-190	L-D Metalik Data Prizi (Cat6A)	340,24	60
	500-00XX05-126	L-D Metalik İkili Data Prizi (2 x Cat6)	409,12	60
	500-00XX05-183	L-D Metalik İkili Data Prizi (2 x Cat6) Toz Kapaklı	412,15	60
	500-00XX05-202	L-D Metalik İkili Data Prizi (2 x Cat6A)	412,15	60
	500-00XX05-132	L-D Metalik Data + Numeris Telefon Prizi (Cat6 x Cat3)	308,56	60
	500-00XX05-184	L-D Metalik Numeris Cat3+F Konnektör	223,16	60
	500-00XX05-185	L-D Metalik Data Cat6+F Konnektör	308,56	60
	500-00XX05-130	L-D Metalik F Konnektör Bağlantı Aparatı	176,64	60
	500-00XX05-127	L-D Metalik TV Priz Sonlu Dişi F Konn Bağlantılı	165,30	60
	500-00XX05-137	L-D Metalik TV Priz Ekran Geçişli Dişi	242,44	60
	500-00XX05-138	L-D Metalik TV Priz Ekran Sonlu Dişi	242,44	60
	500-00XX05-170	L-D Metalik TV Priz Ekranlı Geçişli Erkek	242,44	60
	500-00XX05-171	L-D Metalik TV Priz Ekranlı Sonlu Erkek	242,44	60
	500-00XX05-148	L-D Metalik Tekli Uydu Prizi Geçişli	275,50	60
	500-00XX05-149	L-D Metalik Tekli Uydu Prizi Sonlu	275,50	60
	500-00XX05-139	L-D Metalik TV + Sat - Geçişli	484,88	60
	500-00XX05-140	L-D Metalik TV + Sat - Sonlu	484,88	60
	500-00XX07-146	L-D Metalik TV-R-Sat Geçişli	573,04	60
	500-00XX05-142	L-D Metalik 2'li Müzik Yayın Prizi	595,08	60
	500-00XX05-181	L-D Metalik Audio Prizi	495,90	12
	500-00XX05-180	L-D Metalik VGA Prizi	914,66	12
	500-00XX05-144	L-D Metalik USB Data	264,48	12

XX: 20 FÜME, 21 GÜMÜŞ, 22 TİTANYUM, 23 AÇIK FÜME, 24 ANTRASİT

GÖRSEL	VİDALI KOD	ÜRÜN ADI	FİYAT (TL)	KOLİ ADET
İLETİŞİM GRUBU				
	500-00XX05-145	L-D Metalik HDMI Data	352,64	12
	500-00XX05-195	L-D Metalik HDMI +USB Priz	440,80	12
	500-00XX05-197	L-D Metalik Fiber Data Prizi (Mavi)	154,28	30
	500-00XX05-203	L-D Metalik USB + TYPE C Şarj Priz	771,40	30
	500-00XX05-150	L-D Metalik Data Prizi (Soketsiz)	123,65	60
	500-00XX05-151	L-D Metalik İkili Data Prizi (Soketsiz)	123,65	60
	500-00XX05-175	L-D Metalik Kablo Çıkış Kapağı	123,65	60
ELEKTRONİK GRUBU				
	500-00XX05-136	L-D Metalik Energy Saver Optik (24V)	661,20	1
	500-00XX05-152	L-D Metalik Energy Saver Mekanik (220V)	151,53	30
	500-00XX25-136	L-D Metalik RFID Energy Saver	2.534,60	1
	500-00XX25-201	L-D Metalik RFID Energy Saver Boş Modül	132,24	1
	500-00XX05-134	L-D Metalik Dimmer 800W	484,88	30
	500-00XX05-135	L-D Metalik Dimmer Filtreli 500W	925,68	30
	500-00XX05-147	L-D Metalik Veavien Dimmer 300W	925,68	30
	500-00XX05-179	L-D Metalik RC Dimmer 3W-250W LED	1.366,48	30
	500-00XX06-123	L-D Metalik Müzik Yayın Anahtarı	661,20	12
	500-00XX05-133	L-D Metalik Buzzer Zil	371,93	30
	210-000600-012	Energy Saver Röle VRV RFID 2x16A 13.56 MHZ	2.204,00	1
	210-000600-014	Energy Saver Röle VRV RFID 3x16A 13.56 MHZ	2.424,40	1
	210-000600-001	Energy Saver Röle 1x16A + 1x30A	2.314,20	1
	210-000600-004	Energy Saver Röle 2x16A	2.093,80	1
	500-00XX05-186	L-D Metalik Otel Uyarı Sistemi İç Ünite	165,30	1
	500-00XX05-187	L-D Metalik Otel Uyarı Sistemi Dış Ünite	352,64	1
	210-000600-002	Energy Saver Yan Çizgili Kart Optik	154,28	1
	210-000600-015	Energy Saver Kart RFID 13.56 MHZ	176,32	1
	210-000600-016	Energy Saver Kart-Optik Modüler	154,28	1
	210-000600-007	Kapı ve Pencere Switch	209,38	1
BEYAZ ÇERÇEVE GRUBU				
	107-900000-160	Style Plexy Beyaz Tekli Çerçeve	371,20	5
	107-900000-161	Style Plexy Beyaz İkili Çerçeve	603,20	5
	107-900000-162	Style Plexy Beyaz Üçlü Çerçeve	788,80	5
	107-900000-163	Style Plexy Beyaz Dörtlü Çerçeve	997,60	5
	107-900000-164	Style Plexy Beyaz Beşli Çerçeve	1.252,80	5
SİYAH ÇERÇEVE GRUBU				
	107-910000-160	Style Plexy Siyah Tekli Çerçeve	371,20	5
	107-910000-161	Style Plexy Siyah İkili Çerçeve	603,20	5
	107-910000-162	Style Plexy Siyah Üçlü Çerçeve	788,80	5
	107-910000-163	Style Plexy Siyah Dörtlü Çerçeve	997,60	5
	107-910000-164	Style Plexy Siyah Beşli Çerçeve	1.252,80	5
GOLD ÇERÇEVE GRUBU				
	107-910000-160	Style Plexy Gold Tekli Çerçeve	371,20	5
	107-910000-161	Style Plexy Gold İkili Çerçeve	603,20	5
	107-910000-162	Style Plexy Gold Üçlü Çerçeve	788,80	5
	107-910000-163	Style Plexy Gold Dörtlü Çerçeve	997,60	5
	107-910000-164	Style Plexy Gold Beşli Çerçeve	1.252,80	5

DÜĞME RENGİ KODLARI



XX:20
Füme



XX:21
Gümüş



XX:22
Titanium



XX:23
Açık Füme



XX:24
Antracite

Style
wood



Doğal ve
Zarif



AHŞABIN EN DOĞAL HALİ

STYLE WOOD tasarımında, ahşap yüksek teknoloji ve estetik ile birleşiyor. Kare şeklinin geometrik rasyonalitesi, çerçevenin hafifliği ve zarifliği ile arttırılmıştır. Akçaağaç, Bambu, Kiraz, Ceviz ve Venge ile 5 renkten oluşan şık bir renk aralığı sunar.

RENKLER



Akçaağaç



Bambu







Kiraz









Ceviz



Venge

GÖRSEL	VİDALI KOD	ÜRÜN ADI	FİYAT (TL)	KOLİ ADET
ANAHTAR GRUBU				
	500-00XX25-100	L-D Metalik Anahtar	102,35	60
	500-00XX25-102	L-D Metalik Komitatör	138,24	60
	500-00XX25-109	L-D Metalik Veavien	139,97	60
	500-00XX25-112	L-D Metalik Ara Veavien	231,42	60
	500-00XX23-111	L-D Metalik Komitatör Veavien	202,77	60
	500-00XX22-114	L-D Metalik Üçlü Anahtar	190,72	60
	500-00XX02-108	L-D Metalik Üçlü Veavien	231,42	60
	500-00XX25-105	L-D Metalik Light	116,25	60
	500-00XX25-107	L-D Metalik Zil	116,25	60
	500-00XX25-129	L-D Metalik Etiketli İsimli Zil	117,50	60
	500-00XX25-104	L-D Metalik Kapı Otomatığı	116,25	60
	500-00XX25-172	L-D Metalik Otomasyon Anahtarı	168,61	60
	500-00XX25-173	L-D Metalik Otomasyon Komitatör Tek Faz	179,08	60
	500-00XX25-174	L-D Metalik Otomasyon Komitatör Çift Faz	192,85	60
	500-00XX25-191	L-D Metalik Üçlü Light	218,20	60
	500-00XX25-113	L-D Metalik Jaluzi Kumanda	209,44	60
	500-00XX25-159	L-D Metalik Jaluzi Kumanda Tek Tuşlu	197,12	60
500-00XX06-115	L-D Metalik Klima Anahtarı	319,58	60	
500-00XX06-154	L-D Metalik Isıtıcı Anahtarı	319,58	60	
IŞIKLI ANAHTAR GRUBU				
	500-00XX25-101	L-D Metalik Işıklı Anahtar	187,34	60
	500-00XX25-103	L-D Metalik Işıklı Komitatör	198,36	60
	500-00XX25-106	L-D Metalik Işıklı Light	192,85	60
	500-00XX25-155	L-D Metalik Işıklı Zil (220V)	192,85	60
	500-00XX25-110	L-D Metalik Işıklı Veavien	200,56	60
PRİZ GRUBU				
	500-00XX22-116	L-D Metalik Priz	136,37	60
	500-00XX21-117	L-D Metalik Topraklı Priz	141,75	60
	500-00XX21-118	L-D Metalik Kapaklı Topraklı Priz	177,39	60
	500-00XX21-119	L-D Metalik Çocuk Korumalı Topraklı Priz	149,85	60
	500-00XX21-158	L-D Metalik Kapaklı Çocuk Korumalı Topraklı Priz	182,25	60
	500-00XX23-122	L-D Metalik UPS Priz	152,90	60
	500-00XX23-129	L-D Metalik UPS Priz Çocuk Korumalı	157,04	60
İLETİŞİM GRUBU				
	500-00XX05-124	L-D Metalik Numeris Telefon Prizi (RJ11)	150,14	60
	500-00XX25-124	L-D Metalik Numeris Telefon Prizi (Cat3 Model)	187,36	60
	500-00XX05-176	L-D Metalik İkili Numeris (RJ11 + RJ11)	176,32	60
	500-00XX05-131	L-D Metalik İkili Numeris Telefon Prizi (2 x Cat3)	286,52	60
	500-00XX05-125	L-D Metalik Data Prizi (Cat6)	319,68	60
	500-00XX05-182	L-D Metalik Data Prizi (Cat6) Toz Kapaklı	340,24	60
	500-00XX05-190	L-D Metalik Data Prizi (Cat6A)	340,24	60
	500-00XX05-126	L-D Metalik İkili Data Prizi (2 x Cat6)	409,12	60
	500-00XX05-183	L-D Metalik İkili Data Prizi (2 x Cat6) Toz Kapaklı	412,15	60
	500-00XX05-202	L-D Metalik İkili Data Prizi (2 x Cat6A)	412,15	60
	500-00XX05-132	L-D Metalik Data + Numeris Telefon Prizi (Cat6 x Cat3)	308,56	60
	500-00XX05-184	L-D Metalik Numeris Cat3+F Konnektör	223,16	60
	500-00XX05-185	L-D Metalik Data Cat6+F Konnektör	308,56	60
	500-00XX05-130	L-D Metalik F Konnektör Bağlantı Aparatı	176,64	60
	500-00XX05-127	L-D Metalik TV Priz Sonlu Dişi F Konn Bağlantılı	165,30	60
	500-00XX05-137	L-D Metalik TV Priz Ekran Geçişli Dişi	242,44	60
	500-00XX05-138	L-D Metalik TV Priz Ekran Sonlu Dişi	242,44	60
	500-00XX05-170	L-D Metalik TV Priz Ekranlı Geçişli Erkek	242,44	60
	500-00XX05-171	L-D Metalik TV Priz Ekranlı Sonlu Erkek	242,44	60
	500-00XX05-148	L-D Metalik Tekli Uydu Prizi Geçişli	275,50	60
	500-00XX05-149	L-D Metalik Tekli Uydu Prizi Sonlu	275,50	60
	500-00XX05-139	L-D Metalik TV + Sat - Geçişli	484,88	60
	500-00XX05-140	L-D Metalik TV + Sat - Sonlu	484,88	60
	500-00XX07-146	L-D Metalik TV-R-Sat Geçişli	573,04	60
	500-00XX05-142	L-D Metalik 2'li Müzik Yayın Prizi	595,08	60
	500-00XX05-181	L-D Metalik Audio Prizi	495,90	12
	500-00XX05-180	L-D Metalik VGA Prizi	914,66	12
500-00XX05-144	L-D Metalik USB Data	264,48	12	

XX: 20 FÜME, 21 GÜMÜŞ, 22 TİTANYUM, 23 AÇIK FÜME, 24 ANTRASİT

GÖRSEL	VİDALI KOD	ÜRÜN ADI	FİYAT (TL)	KOLİ ADET
İLETİŞİM GRUBU				
	500-00XX05-145	L-D Metalik HDMI Data	352,64	12
	500-00XX05-195	L-D Metalik HDMI +USB Priz	440,80	12
	500-00XX05-197	L-D Metalik Fiber Data Prizi (Mavi)	154,28	30
	500-00XX05-203	L-D Metalik USB + TYPE C Şarj Priz	771,40	30
	500-00XX05-150	L-D Metalik Data Prizi (Soketsiz)	123,65	60
	500-00XX05-151	L-D Metalik İkili Data Prizi (Soketsiz)	123,65	60
	500-00XX05-175	L-D Metalik Kablo Çıkış Kapağı	123,65	60
ELEKTRONİK GRUBU				
	500-00XX05-136	L-D Metalik Energy Saver Optik (24V)	661,20	1
	500-00XX05-152	L-D Metalik Energy Saver Mekanik (220V)	151,53	30
	500-00XX25-136	L-D Metalik RFID Energy Saver	2.534,60	1
	500-00XX25-201	L-D Metalik RFID Energy Saver Boş Modül	132,24	1
	500-00XX05-134	L-D Metalik Dimmer 800W	484,88	30
	500-00XX05-135	L-D Metalik Dimmer Filtreli 500W	925,68	30
	500-00XX05-147	L-D Metalik Veavien Dimmer 300W	925,68	30
	500-00XX05-179	L-D Metalik RC Dimmer 3W-250W LED	1.366,48	30
	500-00XX06-123	L-D Metalik Müzik Yayın Anahtarı	661,20	12
	500-00XX05-133	L-D Metalik Buzzer Zil	371,93	30
	210-000600-012	Energy Saver Röle VRV RFID 2x16A 13.56 MHZ	2.204,00	1
	210-000600-014	Energy Saver Röle VRV RFID 3x16A 13.56 MHZ	2.424,40	1
	210-000600-001	Energy Saver Röle 1x16A + 1x30A	2.314,20	1
	210-000600-004	Energy Saver Röle 2x16A	2.093,80	1
	500-00XX05-186	L-D Metalik Otel Uyarı Sistemi İç Ünite	165,30	1
	500-00XX05-187	L-D Metalik Otel Uyarı Sistemi Dış Ünite	352,64	1
	210-000600-002	Energy Saver Yan Çizgili Kart Optik	154,28	1
210-000600-015	Energy Saver Kart RFID 13.56 MHZ	176,32	1	
210-000600-016	Energy Saver Kart-Optik Modüler	154,28	1	
210-000600-007	Kapı ve Pencere Switch	209,38	1	
KIRAZ ÇERÇEVE GRUBU				
	107-500000-160	Style Wood Kiraz Tekli Çerçeve	440,80	5
	107-500000-161	Style Wood Kiraz İkili Çerçeve	696,00	5
	107-500000-162	Style Wood Kiraz Üçlü Çerçeve	974,40	5
	107-500000-163	Style Wood Kiraz Dörtlü Çerçeve	1.206,40	5
	107-500000-164	Style Wood Kiraz Beşli Çerçeve	1.554,40	5
CEVİZ ÇERÇEVE GRUBU				
	107-510000-160	Style Wood Ceviz Tekli Çerçeve	440,80	5
	107-510000-161	Style Wood Ceviz İkili Çerçeve	696,00	5
	107-510000-162	Style Wood Ceviz Üçlü Çerçeve	974,40	5
	107-510000-163	Style Wood Ceviz Dörtlü Çerçeve	1.206,40	5
	107-510000-164	Style Wood Ceviz Beşli Çerçeve	1.554,40	5
AKÇAAĞAÇ ÇERÇEVE GRUBU				
	107-520000-160	Style Wood Akçaağaç Tekli Çerçeve	440,80	5
	107-520000-161	Style Wood Akçaağaç İkili Çerçeve	696,00	5
	107-520000-162	Style Wood Akçaağaç Üçlü Çerçeve	974,40	5
	107-520000-163	Style Wood Akçaağaç Dörtlü Çerçeve	1.206,40	5
	107-520000-164	Style Wood Akçaağaç Beşli Çerçeve	1.554,40	5
BAMBU ÇERÇEVE GRUBU				
	107-530000-160	Style Wood Bambu Tekli Çerçeve	440,80	5
	107-530000-161	Style Wood Bambu İkili Çerçeve	696,00	5
	107-530000-162	Style Wood Bambu Üçlü Çerçeve	974,40	5
	107-530000-163	Style Wood Bambu Dörtlü Çerçeve	1.206,40	5
	107-530000-164	Style Wood Bambu Beşli Çerçeve	1.554,40	5
VENGE ÇERÇEVE GRUBU				
	107-540000-160	Style Wood Venge Tekli Çerçeve	440,80	5
	107-540000-161	Style Wood Venge İkili Çerçeve	696,00	5
	107-540000-162	Style Wood Venge Üçlü Çerçeve	974,40	5
	107-540000-163	Style Wood Venge Dörtlü Çerçeve	1.206,40	5
	107-540000-164	Style Wood Venge Beşli Çerçeve	1.554,40	5

DÜĞME RENK KODLARI



XX:20
Füme



XX:21
Gümüş



XX:22
Titanium



XX:23
Açık Füme



XX:24
Antrasit

LEON

MODULAR

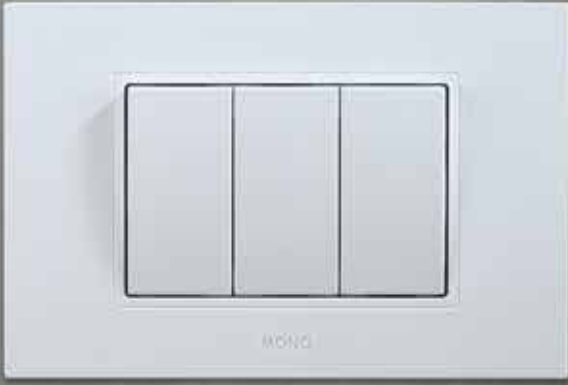

En Popüler,
En Modüler



DÜĞME RENKLERİ

klasik renkler

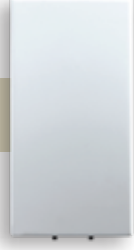

Beyaz

metalik renkler



Gümüş



Füme



Antrasit



Titanyum

MODÜLER ÇERÇEVE RENKLERİ



Beyaz



Gümüş







Füme







Antrasit



Titanyum

GÖRSEL	KOD	ÜRÜN ADI	FİYAT (TL)	KOLİ ADET
ANAHTAR GRUBU				
	505-011945-100	M Seri 1M Anahtar M+K	106,92	30
	505-011945-104	M Seri 1M Kapı Otomatığı M+K	109,35	30
	505-011945-105	M Seri 1M Light M+K	109,35	30
	505-011945-107	M Seri 1M Zil Anahtar M+K	109,35	30
	505-011945-109	M Seri 1M Veavien M+K	126,36	30
	505-011946-112	M Seri 1M Araveavien M+K	182,25	30
	505-011947-159	M Seri 1M 3 Konumlu Jaluzi M+K	133,65	30
	505-011945-102	M Seri 1M İki Kutuplu Anahtar M+K	126,36	30
	505-011945-128	M Seri 1M İpli Acil Uyarı Buton M+K	194,40	30
	505-011945-154	M Seri 1M Isıtıcı Anahtarı 20A	194,40	30
	505-021945-100	M Seri 2M Anahtar M+K	116,64	18
	505-021945-104	M Seri 2M Kapı Otomatığı M+K	119,07	18
	505-021945-105	M Seri 2M Light M+K	119,07	18
	505-021945-107	M Seri 2M Zil Anahtar M+K	119,07	18
	505-021945-109	M Seri 2M Veavien M+K	136,08	18
	505-021946-112	M Seri 2M Araveavien M+K	191,97	18
	505-021947-159	M Seri 2M 3 Konumlu Jaluzi M+K	143,37	18
505-021945-102	M Seri 2M İki Kutuplu Anahtar M+K	136,08	18	
İŞIKLI ANAHTAR GRUBU				
	505-011945-101	M Seri 1M Işıklı Anahtar M+K	145,80	30
	505-011945-106	M Seri 1M Işıklı Light M+K	148,23	30
	505-011945-155	M Seri 1M Işıklı Zil (220V) M+K	148,23	30
	505-011945-110	M Seri 1M Işıklı Veavien M+K	182,25	30
	505-021945-101	M Seri 2M Işıklı Anahtar M+K	155,52	18
	505-021945-106	M Seri 2M Işıklı Light M+K	157,95	18
	505-021945-155	M Seri 2M Işıklı Zil (220V) M+K	157,95	18
	505-021945-110	M Seri 2M Işıklı Veavien M+K	191,97	18
PRİZ GRUBU				
	505-011942-143	M Seri 1M Çoc. Kor. Euro American Priz M+K	121,50	30
	505-021941-119	M Seri 2M Çoc. Kor. Topraklı Priz M+K	126,36	18
	505-021941-158	M Seri 2M Çoc. Kor. Kapaklı Topraklı Priz M+K	131,22	18
	505-021943-129	M Seri 2M Çoc. Kor. UPS Topraklı Priz M+K	133,65	18
İLETİŞİM GRUBU				
	505-011915-144	M Seri 1M USB Priz (Jacklı) M+K	218,70	30
	505-011915-180	M Seri 1M VGA Priz M+K	923,40	30
	505-011915-145	M Seri 1M HDMI Priz M+K	315,90	30
	505-011915-142	M Seri 1M Müzik Yayın Priz Hoparlör Jacklı M+K	437,40	30
	505-011915-181	M Seri 1M Müzik Yayın Priz Kulaklık M+K	486,00	30
	505-011915-162	M Seri 1M RCA Konnektör M+K	267,30	30
	505-011915-124	M Seri 1M Numeris Telefon Prizi Cat3 M+K	145,80	30
	505-011915-125	M Seri 1M Data Prizi (Rj45) Cat6 M+K	194,40	30
	505-011915-138	M Seri 1M TV Prizi Sonlu M+K	291,60	30
	505-011915-137	M Seri 1M TV Prizi Geçişli 20 Db M+K	291,60	30
	505-011915-130	M Seri 1M F Konnektör (Jack) M+K	145,80	30
	505-011915-140	M Seri 1M TV-Sat Prizi Sonlu M+K	461,70	30
	505-011915-139	M Seri 1M TV-Sat Prizi Geçişli 12 Db M+K	461,70	30
	505-011915-120	M Seri 1M Boş Kapak	14,58	30
ELEKTRONİK GRUBU				
	505-021905-136	M Seri 2M Optik Energy Saver M+K	972,00	12
	505-021925-136	M Seri 2M RFID Energy Saver M+K	2.551,50	12
	505-011915-178	M Seri 1M USB Şarj Prizi (1A 5V) M+K	874,80	30
	505-021915-178	M Seri 2M İkili USB Şarj Prizi (2.4A 5V) M+K	777,60	12
	505-021915-203	M Seri 2M USB+TYPE C Şarj Prizi (2.4A 5V) M+K	890,00	12
	505-021915-134	M Seri 2M RL Dimmer Filtresiz 600W M+K	923,40	12
	505-021915-147	M Seri 2M RL Dimmer Veavien Filtresiz 600W M+K	923,40	12
	505-021915-153	M Seri 2M RL Dimmer Veavien Filtreli 400W M+K	972,00	12
	505-021915-179	M Seri 2M RC Ayarlı LED Dimmer 300W M+K	1.458,00	12
	505-021915-123	M Seri 2M Müzik Yayın Anahtarı M+K	972,00	12
	505-021915-188	M Seri 2M Hareket Sensorü M+K	1.458,00	12
	505-021915-187	M Seri 2M Dış Ünite DND M+K	486,00	12
	505-021915-133	M Seri 2M Buzzer Zil M+K	558,90	12
	505-021915-160	M Seri 2M LED Light Sıva Altı M+K	607,50	12
	505-021905-161	M Seri 2M Yönlendirici İkaz Lambası M+K	486,00	12
	505-021915-161	M Seri 2M Yönlendirici Bay Lambası M+K	486,00	12
	505-021925-161	M Seri 2M Yönlendirici Bayan Lambası M+K	486,00	12
	505-021935-161	M Seri 2M Yönlendirici Exit Lambası M+K	486,00	12
	505-021945-161	M Seri 2M Yönlendirici No Smoking Lambası M+K	486,00	12
	505-021955-161	M Seri 2M Yönlendirici OK Lambası M+K	486,00	12
	505-031905-136	M Seri 3M Optik Energy Saver M+K	996,30	12
	505-031925-136	M Seri 3M RFID Energy Saver M+K	2.575,80	12
	210-000600-015	Energy Saver Kart RFID 13.56 MHZ	172,80	1
	210-000600-016	Energy Saver Kart-Optik Modüler	151,20	1
	210-000600-007	Kapı ve Pencere Switch	205,20	1

GÖRSEL	KOD	ÜRÜN ADI	FİYAT (TL)	KOLİ ADET
BEYAZ ÇERÇEVE GRUBU				
	110-190000-002	Round Çerçeve 2M Beyaz	36,45	30
	110-190000-003	Round Çerçeve 3M Beyaz	48,60	25
	110-190000-004	Round Çerçeve 4M Beyaz	58,32	20
	110-190000-007	Round Çerçeve 7M Beyaz	72,90	20
FÜME ÇERÇEVE GRUBU				
	110-200000-002	Round Çerçeve 2M Füme	55,89	30
	110-200000-003	Round Çerçeve 3M Füme	63,18	25
	110-200000-004	Round Çerçeve 4M Füme	72,90	20
	110-200000-007	Round Çerçeve 7M Füme	92,34	20
GÜMÜŞ ÇERÇEVE GRUBU				
	110-210000-002	Round Çerçeve 2M Gümüş	55,89	30
	110-210000-003	Round Çerçeve 3M Gümüş	63,18	25
	110-210000-004	Round Çerçeve 4M Gümüş	72,90	20
	110-210000-007	Round Çerçeve 7M Gümüş	92,34	20
TİTANYUM ÇERÇEVE GRUBU				
	110-220000-002	Round Çerçeve 2M Titanyum	55,89	30
	110-220000-003	Round Çerçeve 3M Titanyum	63,18	25
	110-220000-004	Round Çerçeve 4M Titanyum	72,90	20
	110-220000-007	Round Çerçeve 7M Titanyum	92,34	20
ANTRASİT ÇERÇEVE GRUBU				
	110-240000-002	Round Çerçeve 2M Antrasit	55,89	30
	110-240000-003	Round Çerçeve 3M Antrasit	63,18	25
	110-240000-004	Round Çerçeve 4M Antrasit	72,90	20
	110-240000-007	Round Çerçeve 7M Antrasit	92,34	20

DÜĞME RENK KODLARI

 XX:19
 Beyaz

 XX:20
 Füme

 XX:21
 Gümüş

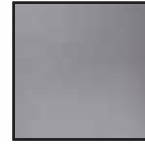
 XX:22
 Titanyum

 XX:24
 Antrasit

LEON
MODULAR LUX



Lüks ve Zarif
Modüler
Çözümler





LÜX MODÜLERLE BİRLEŞTİ

Malzeme, estetik ve maksimum performans ile modern LEON MODÜLER serisi. Çeşitli kullanım alanları içerisindeki ihtiyacınız doğrultusunda mekanlarınızı yenilikçi ve mükemmel yeni nesil LEON MODÜLER ile çözümler sunuyor. İki ayrı kategoride 5 renk düğme, 15 farklı renk ve malzemede çerçeve seçenekleri ile geniş bir alternatif sunuyor.

RENKLER

ALÜMİNYUM



Gümüş



Füme



Bronz



Titanyum

CAM



Siyah



Beyaz

AHŞAP



Bambu



Kiraz



Ceviz



Venge

DÜĞME RENKLERİ

klasik renkler



Beyaz

metalik renkler



Gümüş



Füme



Antrasit



Titanyum

MODÜLER LÜX ÇERÇEVE RENKLERİ

ALÜMİNYUM



Gümüş

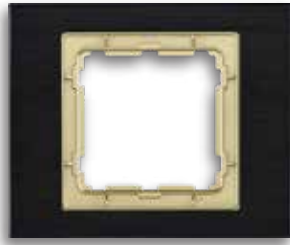

Füme



Bronz



Titanyum

CAM

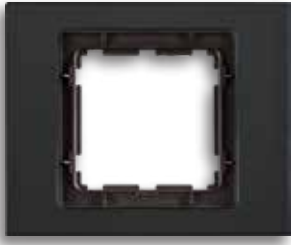

Siyah



Beyaz

AHŞAP

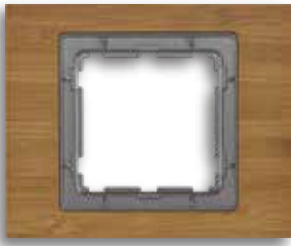

Bambu



Kiraz







Ceviz



Venge

GÖRSEL	KOD	ÜRÜN ADI	FİYAT (TL)	KOLİ ADET
ANAHTAR GRUBU				
	505-01XX45-100	M Seri 1M Metalik Anahtar M+K	128,79	30
	505-01XX45-104	M Seri 1M Metalik Kapı Otomatığı M+K	131,22	30
	505-01XX45-105	M Seri 1M Metalik Light M+K	131,22	30
	505-01XX45-107	M Seri 1M Metalik Zil Anahtar M+K	131,22	30
	505-01XX45-109	M Seri 1M Metalik Veavien M+K	148,23	30
	505-01XX46-112	M Seri 1M Metalik Araveavien M+K	204,12	30
	505-01XX47-159	M Seri 1M Metalik 3 Konumlu Jaluzi M+K	157,95	30
	505-01XX45-102	M Seri 1M Metalik İki Kutuplu Anahtar M+K	148,23	30
	505-01XX45-128	M Seri 1M Metalik İpli Acil Uyarı Buton M+K	216,27	30
	505-01XX45-154	M Seri 1M Metalik Isıtıcı Anahtarı 20A	216,27	30
	505-02XX45-100	M Seri 2M Metalik Anahtar M+K	138,51	18
	505-02XX45-104	M Seri 2M Metalik Kapı Otomatığı M+K	140,94	18
	505-02XX45-105	M Seri 2M Metalik Light M+K	140,94	18
	505-02XX45-107	M Seri 2M Metalik Zil Anahtar M+K	140,94	18
	505-02XX45-109	M Seri 2M Metalik Veavien M+K	157,95	18
	505-02XX46-112	M Seri 2M Metalik Araveavien M+K	213,84	18
	505-02XX47-159	M Seri 2M Metalik 3 Konumlu Jaluzi M+K	165,24	18
505-02XX45-102	M Seri 2M Metalik İki Kutuplu Anahtar M+K	157,95	18	
İŞIKLI ANAHTAR GRUBU				
	505-01XX45-101	M Seri 1M Metalik Işıklı Anahtar M+K	167,67	30
	505-01XX45-106	M Seri 1M Metalik Işıklı Light M+K	170,10	30
	505-01XX45-155	M Seri 1M Metalik Işıklı Zil (220V) M+K	170,10	30
	505-01XX45-110	M Seri 1M Metalik Işıklı Veavien M+K	204,12	30
	505-02XX45-101	M Seri 2M Metalik Işıklı Anahtar M+K	177,39	18
	505-02XX45-106	M Seri 2M Metalik Işıklı Light M+K	179,82	18
	505-02XX45-155	M Seri 2M Metalik Işıklı Zil (220V) M+K	179,82	18
505-02XX45-110	M Seri 2M Metalik Işıklı Veavien M+K	213,84	18	
PRİZ GRUBU				
	505-01XX42-143	M Seri 1M Metalik Çoc. Kor. Euro American Priz M+K	145,80	30
	505-02XX41-119	M Seri 2M Metalik Çoc. Kor. Topraklı Priz M+K	145,80	18
	505-02XX41-158	M Seri 2M Metalik Çoc. Kor. Kapaklı Topraklı Priz M+K	150,66	18
	505-02XX43-129	M Seri 2M Metalik Çoc. Kor. UPS Topraklı Priz M+K	153,09	18
İLETİŞİM GRUBU				
	505-01XX15-144	M Seri 1M Metalik USB Priz (Jacklı) M+K	230,85	30
	505-01XX15-180	M Seri 1M Metalik VGA Priz M+K	947,70	30
	505-01XX15-145	M Seri 1M Metalik HDMI Priz M+K	328,05	30
	505-01XX15-142	M Seri 1M Metalik Müzik Yayın Priz Hoparlör Jacklı M+K	449,55	30
	505-01XX15-181	M Seri 1M Metalik Müzik Yayın Priz Kulaklık M+K	607,50	30
	505-01XX15-162	M Seri 1M Metalik RCA Konnektör M+K	279,45	30
	505-01XX15-124	M Seri 1M Metalik Numeris Telefon Prizi Cat3 M+K	170,10	30
	505-01XX15-125	M Seri 1M Metalik Data Prizi (Rj45) Cat6 M+K	218,70	30
	505-01XX15-138	M Seri 1M Metalik TV Prizi Sonlu M+K	303,75	30
	505-01XX15-137	M Seri 1M Metalik TV Prizi Geçişli 20 Db M+K	303,75	30
	505-01XX15-130	M Seri 1M Metalik F Konnektör (Jack) M+K	170,10	30
	505-01XX15-140	M Seri 1M Metalik TV-Sat Prizi Sonlu M+K	473,85	30
	505-01XX15-139	M Seri 1M Metalik TV-Sat Prizi Geçişli 12 Db M+K	473,85	30
	505-01XX15-120	M Seri 1M Metalik Boş Kapak	26,73	30
ELEKTRONİK GRUBU				
	505-02XX05-136	M Seri 2M Metalik Optik Energy Saver M+K	996,30	12
	505-02XX25-136	M Seri 2M Metalik RFID Energy Saver M+K	2.575,80	12
	505-01XX15-178	M Seri 1M Metalik USB Şarj Prizi (1A 5V) M+K	899,10	30
	505-02XX15-178	M Seri 2M Metalik İkili USB Şarj Prizi (2.4A 5V) M+K	826,20	12
	505-02XX15-203	M Seri 2M Metalik USB+Type C Şarj Prizi (2.4A 5V) M+K	902,00	12
	505-02XX15-134	M Seri 2M Metalik RL Dimmer Filtresiz 600W M+K	947,70	12
	505-02XX15-147	M Seri 2M Metalik RL Dimmer Veavien Filtresiz 600W M+K	947,70	12
	505-02XX15-153	M Seri 2M Metalik RL Dimmer Veavien Filtreli 400W M+K	1.117,80	12
	505-02XX15-179	M Seri 2M Metalik RC Ayarlı LED Dimmer 300W M+K	1.482,30	12
	505-02XX15-123	M Seri 2M Metalik Müzik Yayın Anahtarı M+K	996,30	12
	505-02XX15-188	M Seri 2M Metalik Hareket Sensorü M+K	1.482,30	12
	505-02XX15-187	M Seri 2M Metalik Dış Ünite DND M+K	510,30	12
	505-02XX15-133	M Seri 2M Metalik Buzzer Zil M+K	583,20	12
	505-02XX15-160	M Seri 2M Metalik LED Light Sıva Altı M+K	631,80	12
	505-02XX05-161	M Seri 2M Metalik Yönlendirici İkaz Lambası M+K	510,30	12
	505-02XX15-161	M Seri 2M Metalik Yönlendirici Bay Lambası M+K	510,30	12
	505-02XX25-161	M Seri 2M Metalik Yönlendirici Bayan Lambası M+K	510,30	12
	505-02XX35-161	M Seri 2M Metalik Yönlendirici Exit Lambası M+K	510,30	12
	505-02XX45-161	M Seri 2M Metalik Yönlendirici No Smoking Lambası M+K	510,30	12
	505-02XX55-161	M Seri 2M Metalik Yönlendirici Ok Lambası M+K	510,30	12
	505-03XX05-136	M Seri 3M Metalik Optik Energy Saver M+K	1.020,60	12
	505-03XX25-136	M Seri 3M Metalik RFID Energy Saver M+K	2.600,10	12
	210-000600-015	Energy Saver Kart RFID 13.56 MHZ	172,80	1
	210-000600-016	Energy Saver Kart-Optik Modüler	151,20	1
	210-000600-007	Kapı ve Pencere Switch	205,20	1

GÖRSEL	KOD	ÜRÜN ADI	FİYAT (TL)	KOLİ ADET	
ALÜMİNYUM ÇERÇEVE GRUBU					
	111-800000-002	Lüks Flat Alüminyum Gümüş Çerçeve 2M	388,80	30	
	111-800000-003	Lüks Flat Alüminyum Gümüş Çerçeve 3M	437,40	25	
	111-800000-004	Lüks Flat Alüminyum Gümüş Çerçeve 4M	510,30	20	
	111-800000-007	Lüks Flat Alüminyum Gümüş Çerçeve 7M	607,50	20	
	111-810000-002	Lüks Flat Alüminyum Bronz Çerçeve 2M	388,80	30	
	111-810000-003	Lüks Flat Alüminyum Bronz Çerçeve 3M	437,40	25	
	111-810000-004	Lüks Flat Alüminyum Bronz Çerçeve 4M	510,30	20	
	111-810000-007	Lüks Flat Alüminyum Bronz Çerçeve 7M	607,50	20	
	111-820000-002	Lüks Flat Alüminyum Füme Çerçeve 2M	388,80	30	
	111-820000-003	Lüks Flat Alüminyum Füme Çerçeve 3M	437,40	25	
	111-820000-004	Lüks Flat Alüminyum Füme Çerçeve 4M	510,30	20	
	111-820000-007	Lüks Flat Alüminyum Füme Çerçeve 7M	607,50	20	
	111-830000-002	Lüks Flat Alüminyum Şampanya Çerçeve 2M	388,80	30	
	111-830000-003	Lüks Flat Alüminyum Şampanya Çerçeve 3M	437,40	25	
111-830000-004	Lüks Flat Alüminyum Şampanya Çerçeve 4M	510,30	20		
111-830000-007	Lüks Flat Alüminyum Şampanya Çerçeve 7M	607,50	20		
AHŞAP ÇERÇEVE GRUBU					
	111-500000-002	Lüks Flat Kiraz Çerçeve 2M	340,20	30	
	111-500000-003	Lüks Flat Kiraz Çerçeve 3M	413,10	25	
	111-500000-004	Lüks Flat Kiraz Çerçeve 4M	510,30	20	
	111-500000-007	Lüks Flat Kiraz Çerçeve 7M	631,80	20	
	111-510000-002	Lüks Flat Ceviz Çerçeve 2M	340,20	30	
	111-510000-003	Lüks Flat Ceviz Çerçeve 3M	413,10	25	
	111-510000-004	Lüks Flat Ceviz Çerçeve 4M	510,30	20	
	111-510000-007	Lüks Flat Ceviz Çerçeve 7M	631,80	20	
	111-530000-002	Lüks Flat Bambu Çerçeve 2M	340,20	30	
	111-530000-003	Lüks Flat Bambu Çerçeve 3M	413,10	25	
	111-530000-004	Lüks Flat Bambu Çerçeve 4M	510,30	20	
	111-530000-007	Lüks Flat Bambu Çerçeve 7M	631,80	20	
	111-540000-002	Lüks Flat Venge Çerçeve 2M	340,20	30	
	111-540000-003	Lüks Flat Venge Çerçeve 3M	413,10	25	
111-540000-004	Lüks Flat Venge Çerçeve 4M	510,30	20		
111-540000-007	Lüks Flat Venge Çerçeve 7M	631,80	20		
CAM ÇERÇEVE GRUBU					
	111-710000-002	Lüks Flat Beyaz Cam Çerçeve 2M	1.117,80	30	
	111-710000-003	Lüks Flat Beyaz Cam Çerçeve 3M	1.215,00	25	
	111-710000-004	Lüks Flat Beyaz Cam Çerçeve 4M	1.312,20	20	
	111-710000-007	Lüks Flat Beyaz Cam Çerçeve 7M	1.579,50	20	
	111-720000-002	Lüks Flat Siyah Cam Çerçeve 2M	1.117,80	30	
	111-720000-003	Lüks Flat Siyah Cam Çerçeve 3M	1.215,00	25	
	111-720000-004	Lüks Flat Siyah Cam Çerçeve 4M	1.312,20	20	
	111-720000-007	Lüks Flat Siyah Cam Çerçeve 7M	1.579,50	20	
	KORDON GRUBU				
		111-001900-152	Lüks Flat Buz Beyaz Kordon 2M	12,15	30
111-001900-153		Lüks Flat Buz Beyaz Kordon 3M	14,58	25	
111-001900-154		Lüks Flat Buz Beyaz Kordon 4M	17,01	20	
111-001900-157		Lüks Flat Buz Beyaz Kordon 7M	19,44	20	
111-002000-152		Lüks Flat Füme Kordon 2M	19,44	30	
111-002000-153		Lüks Flat Füme Kordon 3M	20,79	25	
111-002000-154		Lüks Flat Füme Kordon 4M	21,87	20	
111-002000-157		Lüks Flat Füme Kordon 7M	26,73	20	
111-002100-152		Lüks Flat Gümüş Kordon 2M	19,44	30	
111-002100-153		Lüks Flat Gümüş Kordon 3M	20,79	25	
111-002100-154		Lüks Flat Gümüş Kordon 4M	21,87	20	
111-002100-157		Lüks Flat Gümüş Kordon 7M	26,73	20	
111-002200-152		Lüks Flat Titanyum Kordon 2M	19,44	30	
111-002200-153		Lüks Flat Titanyum Kordon 3M	20,79	25	
111-002200-154		Lüks Flat Titanyum Kordon 4M	21,87	20	
111-002200-157		Lüks Flat Titanyum Kordon 7M	26,73	20	
111-002400-152		Lüks Flat Antrasit Kordon 2M	19,44	30	
111-002400-153		Lüks Flat Antrasit Kordon 3M	20,79	25	
111-002400-154	Lüks Flat Antrasit Kordon 4M	21,87	20		
111-002400-157	Lüks Flat Antrasit Kordon 7M	26,73	20		

Karkas

GÖRSEL	KOD	ÜRÜN ADI	FİYAT (TL)	KOLİ ADET
KARKAS GRUBU				
	400-010000-002	Modüler Seri 2M Karkas / Şase	38,88	36
	400-010000-003	Modüler Seri 3M Karkas / Şase	48,60	24
	400-010000-004	Modüler Seri 4M Karkas / Şase	53,46	20
	400-010000-007	Modüler Seri 7M Karkas / Şase	65,61	12
	400-020000-002	Modüler Seri 2M Karkas / Tırnaklı	41,31	14

Kasa

KASA GRUBU				
	190-010000-002	Modüler Seri 2M Alt Kasa	20,66	120
	190-010000-003	Modüler Seri 3M Alt Kasa	25,52	84
	190-010000-004	Modüler Seri 4M Alt Kasa	30,38	66
	190-010000-007	Modüler Seri 7M Alt Kasa	42,53	48

KARKAS GRUBU

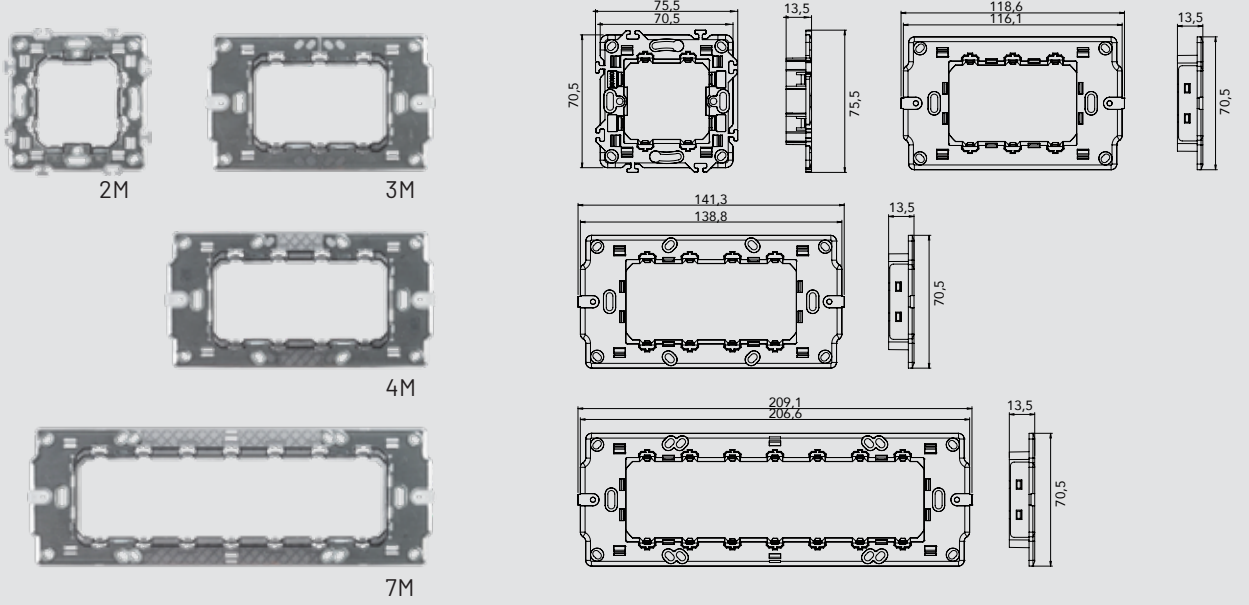

KASA GRUBU

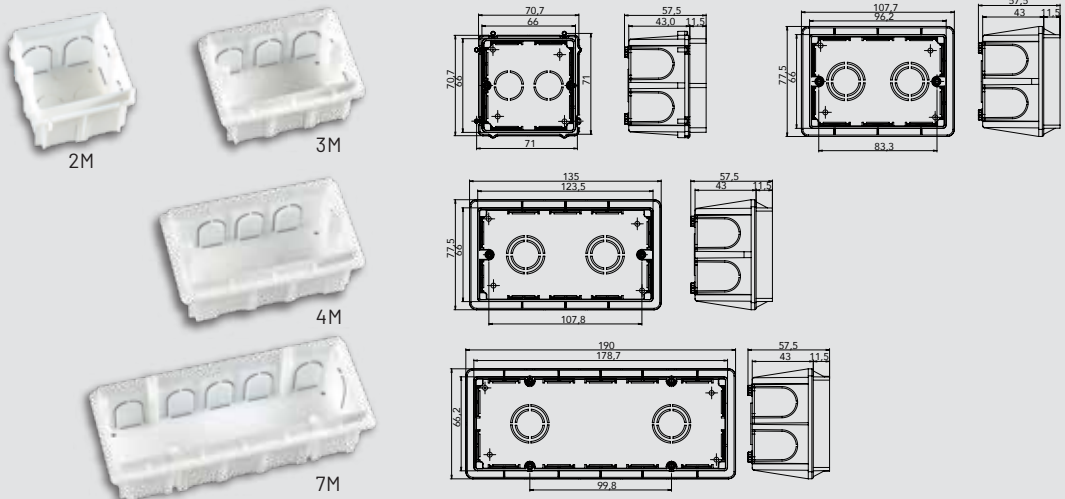





monte



Renkleri
Seviyoruz



GÖRSEL	KOD	ÜRÜN ADI	FİYAT (TL)	KOLİ ADET
ANAHTAR GRUBU				
	502-000101-100	Monte Anahtar	87,48	120
	502-000101-102	Monte Komitatör	118,80	120
	502-000101-109	Monte Veavien	120,96	120
	502-000101-111	Monte Komitatör Veavien	151,20	60
	502-000101-112	Monte Ara Veavien	179,28	60
	502-000101-114	Monte Üçlü Anahtar	129,60	60
	502-000101-108	Monte Üçlü Veavien	172,80	60
	502-000101-105	Monte Light	91,80	120
	502-000101-107	Monte Zil	91,80	120
	502-000101-104	Monte Kapı Otomatığı	91,80	60
	502-000101-113	Monte Jaluzi Kumanda	133,92	60
	502-000101-115	Monte Klima Anahtarı	259,20	60
IŞIKLI ANAHTAR GRUBU				
	502-000101-101	Monte Işıklı Anahtar	136,08	60
	502-000101-103	Monte Işıklı Komitatör	146,88	60
	502-000101-106	Monte Işıklı Light	140,40	60
	502-000101-155	Monte Işıklı Zil (220V)	140,40	60
	502-000101-110	Monte Işıklı Veavien	146,88	60
PRİZ GRUBU				
	502-000106-116	Monte Priz	93,15	120
	502-000106-143	Monte Çocuk Korumalı Priz	97,20	120
	502-000107-117	Monte Topraklı Priz	105,30	120
	502-000107-118	Monte Kapaklı Topraklı Priz	109,35	120
	502-000107-119	Monte Çocuk Korumalı Topraklı Priz	109,35	120
	502-000109-122	Monte UPS Priz	111,38	60
	502-000109-129	Monte Çocuk Korumalı UPS	115,43	60
İLETİŞİM GRUBU				
	502-000104-124	Monte Numeris Telefon Prizi (Rj11)	108,00	120
	502-000104-125	Monte Data Prizi (Cat6)	218,70	60
	502-000104-126	Monte İkili Data Prizi (2 x Cat6)	315,90	60
	502-000104-127	Monte TV Priz Geçişli	118,80	120
	502-000104-128	Monte TV Priz Sonlu	118,80	120
	502-000104-130	Monte F Konnektör Bağlantı Aparatı	105,84	120
	502-000104-131	Monte İkili Numeris Telefon Prizi Cat3	216,00	60
	502-000104-132	Monte Data + Numeris Telefon Prizi (Cat6 x Cat3)	237,60	60
	502-000104-139	Monte TV + Sat Priz Geçişli	432,00	60
	502-000104-140	Monte TV + Sat Priz Sonlu	432,00	60
	502-000104-150	Monte Data Prizi (Soketsiz)	84,24	60
	502-000104-151	Monte İkili Data Prizi (Soketsiz)	84,24	60
	KORDON ve ÇERÇEVE GRUBU			
	105-00XX00-150	Monte Tekli Kordon	2,16	500
	105-00XX00-153	Monte İkili Priz Kordon	4,66	100
	105-010000-160	Monte Tekli Çerçeve	8,64	150
	105-010000-161	Monte İkili Çerçeve	32,40	100
	105-010000-162	Monte Üçlü Çerçeve	54,00	90
	105-010000-163	Monte Dörtlü Çerçeve	64,80	40
	105-010000-164	Monte Beşli Çerçeve	77,76	40



XX: 02 Gri



XX: 03 Yeşil



XX: 04 Bej



XX: 05 Açık Bej



XX: 06 Mavi



XX: 07 Açık Mavi



XX: 08 Kahve



XX: 09 Sarı



XX: 10 Açık Lila



XX: 11 Koyu Lila



XX: 12 Pembe



XX: 13 Siyah



XX: 14 Bordo







XX: 15 Krem

octans



Kolay
Montaj



GÖRSEL	KOD	ÜRÜN ADI	FİYAT (TL)	KOLİ ADET
ANAHTAR GRUBU				
	104-XXXX01-100	Octans Anahtar	89,10	120
	104-XXXX01-102	Octans Komitatör	112,80	120
	104-XXXX01-109	Octans Veavien	126,90	120
	104-XXXX01-111	Octans Komitatör Veavien	172,80	60
	104-XXXX01-112	Octans Ara Veavien	205,20	60
	104-XXXX01-114	Octans Üçlü Anahtar	151,20	60
	104-XXXX01-108	Octans Üçlü Veavien	200,88	60
	104-XXXX01-105	Octans Light	97,50	60
	104-XXXX01-107	Octans Zil	97,50	60
	104-XXXX01-104	Octans Kapı Otomatiği	97,50	60
	104-XXXX01-113	Octans Jaluzi Kumanda	157,68	60
	104-XXXX01-115	Octans Klima Anahtarı	291,60	60
İŞIKLI ANAHTAR GRUBU				
	104-XXXX01-101	Octans Işıklı Anahtar	140,16	60
	104-XXXX01-103	Octans Işıklı Komitatör	149,76	60
	104-XXXX01-106	Octans Işıklı Light	148,00	60
	104-XXXX01-110	Octans Işıklı Veavien	168,42	60
	104-XXXX01-155	Octans Işıklı Zil (220V)	148,00	60
PRİZ GRUBU				
	104-XXXX06-116	Octans Priz	111,38	120
	104-XXXX06-143	Octans Çocuk Korumalı Priz	115,02	120
	104-XXXX07-117	Octans Topraklı Priz	117,45	120
	104-XXXX07-118	Octans Kapaklı Topraklı Priz	121,50	120
	104-XXXX07-119	Octans Çocuk Korumalı Topraklı Priz	121,50	120
	104-XXXX09-122	Octans UPS Priz	125,55	60
	104-XXXX09-129	Octans Çocuk Korumalı UPS Priz	129,60	60
İLETİŞİM GRUBU				
	104-XXXX04-124	Octans Numeris Telefon Prizi (Cat3)	123,12	60
	104-XXXX04-125	Octans Data Prizi (Cat6)	270,00	60
	104-XXXX04-126	Octans İkili Data Prizi (2 x Cat6)	367,20	60
	104-XXXX04-127	Octans TV Priz Geçişli	129,60	60
	104-XXXX04-128	Octans TV Priz Sonlu	129,60	60
	104-XXXX04-130	Octans F Konnektör Bağlantı Aparatı	116,64	60
	104-XXXX04-131	Octans İkili Numeris Telefon Prizi (2 x Cat3)	237,60	60
	104-XXXX04-132	Octans Data + Numeris Telefon Prizi (Cat6 x Cat3)	270,00	60
İKİLİ GRUPLAR				
	104-XXXX01-180	Octans Anahtar + Topraklı Priz	179,28	60
	104-XXXX01-181	Octans Komitatör + Topraklı Priz	196,56	60
	104-XXXX01-182	Octans Komitatör + Priz	177,12	60
	104-XXXX01-183	Octans Anahtar + Kapaklı Topraklı Priz	181,44	60
	104-XXXX07-120	Octans Topraklı Priz + Topraklı Priz	190,08	60
	104-XXXX06-121	Octans Priz + Priz	162,00	60
	104-XXXX01-184	Octans Kapaklı Topraklı Priz + Kapaklı Topraklı Priz	194,40	60
	104-XXXX01-185	Octans Anahtar + Priz	168,48	60
	104-XXXX01-186	Octans Veavien + Topraklı Priz	194,40	60
	104-XXXX01-187	Octans Komitatör + Kapaklı Topraklı Priz	198,45	60
104-XXXX01-188	Octans Anahtar + Anahtar	164,16	60	

XXXX: 0101 BEYAZ, 0200 GRİ

ÇERÇEVE RENKLERİ



Beyaz + Beyaz



Beyaz + Gri

Octans
IP54



Dış Etkilere
Karşı
Mükemmel
Koruma

NEW
COLLECTION



TÜVRheinland®

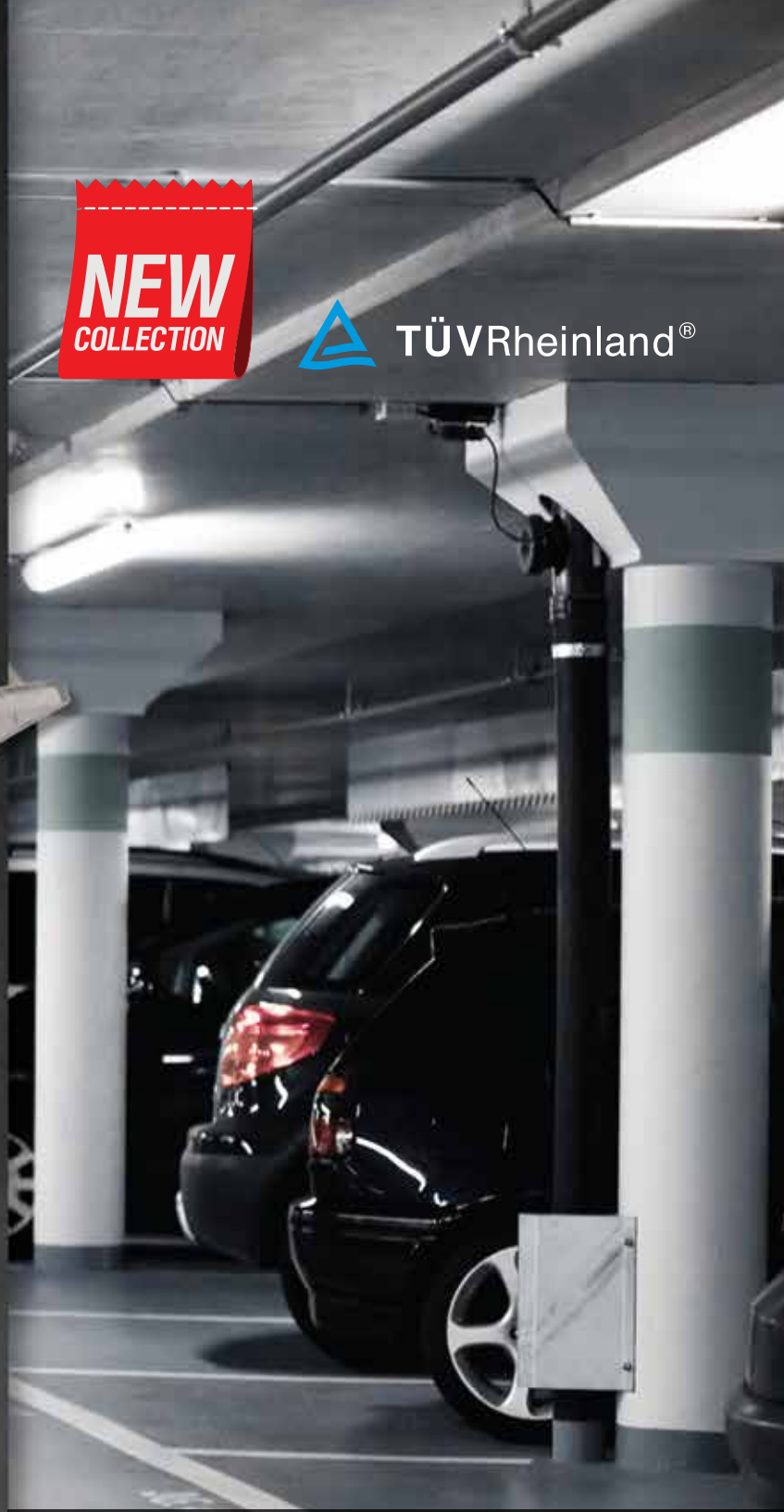

Uygulama Alanları:

- ✓ Havuz Kenarı
- ✓ Garaj
- ✓ Balkon
- ✓ Bahçe

Octans IP54 Komple Ürün

GÖRSEL	KOD	ÜRÜN ADI	FİYAT (TL)	KOLİ ADET
ANAHTAR GRUBU				
	154-XX0001-100	Octans IP54 Anahtar	113,40	90
	154-XX0001-102	Octans IP54 Komitatör	156,60	90
	154-XX0001-104	Octans IP54 Kapı Otomatiği	135,00	90
	154-XX0001-105	Octans IP54 Light	135,00	90
	154-XX0001-107	Octans IP54 Zil	135,00	90
	154-XX0001-109	Octans IP54 Veavien	156,60	90
	154-XX0001-111	Octans IP54 Komitatör Veavien	205,20	90
	154-XX0001-112	Octans IP54 Ara Veavien	237,60	90
	154-XX0001-113	Octans IP54 Jaluzi Kumanda	187,92	90
	154-XX0001-115	Octans IP54 Klima Anahtarı (Işıksız)	313,20	90
PRİZ GRUBU				
	154-XX0006-116	Octans IP54 Priz	141,75	90
	154-XX0006-143	Octans IP54 Çocuk Korumalı Priz	144,45	90
	154-XX0007-117	Octans IP54 Topraklı Priz	145,80	90
	154-XX0007-119	Octans IP54 Çocuk Korumalı Topraklı Priz	147,83	90
	154-XX0009-122	Octans IP54 UPS Priz	151,88	90
	154-XX0009-129	Octans IP54 UPS Çocuk Korumalı Priz	153,90	90
İKİLİ GRUPLAR				
	154-XX0006-121	Octans IP54 Priz+Priz	224,64	40
	154-XX0001-178	Octans IP54 Veavien+Veavien	250,56	40
	154-XX0001-197	Octans IP54 Komütatör+Veavien	259,20	40
	154-XX0001-180	Octans IP54 Anahtar+Topraklı Priz	244,08	40
	154-XX0001-181	Octans IP54 Komitatör+Topraklı Priz	250,56	40
	154-XX0001-182	Octans IP54 Komitatör+Priz	241,92	40
	154-XX0007-120	Octans IP54 Topraklı Priz+Topraklı Priz	226,80	40
	154-XX0001-185	Octans IP54 Anahtar+Priz	233,28	40
	154-XX0001-186	Octans IP54 Veavien+Topraklı Priz	250,56	40
	154-XX0001-188	Octans IP54 Anahtar+Anahtar	224,64	40
	154-XX0001-190	Octans IP54 Çocuk Korumalı Priz+Çocuk Korumalı Priz	220,32	40
	154-XX0001-192	Octans IP54 Çocuk Korumalı Topraklı Priz+Çocuk Korumalı Topraklı Priz	241,92	40
	154-XX0001-193	Octans IP54 Anahtar+Çocuk Korumalı Topraklı Priz	237,60	40
	154-XX0001-179	Octans IP54 Anahtar+Komütatör	252,72	40
	154-XX0001-177	Octans IP54 Komütatör+Komütatör	250,56	40
154-XX0001-196	Octans IP54 Anahtar+Veavien	250,56	40	
İLETİŞİM GRUBU				
	154-XX0004-124	Octans IP54 Kapaklı Numeris Telefon Priz Rj11	155,52	90
	154-XX0004-125	Octans IP54 Kapaklı Data Priz (Rj45 Cat6)	297,00	90
	154-XX0004-126	Octans IP54 Kapaklı İkili Data Priz	391,50	90
	154-XX0004-127	Octans IP54 Kapaklı Tv Priz Geçişli	162,00	90
	154-XX0004-128	Octans IP54 Kapaklı Tv Priz Sonlu	162,00	90
	154-XX0004-130	Octans IP54 Kapaklı Uydu Priz (F Konn.)	149,04	90
	154-XX0004-131	Octans IP54 Kapaklı İkili Numeris Tlf. Priz (Rj45 Cat3+Cat3)	270,00	90
	154-XX0004-132	Octans IP54 Kapaklı Data+Numeris Tlf. (Rj45 Cat6+Cat3)	291,60	90

XX: 01 BEYAZ, 02 GRİ

RENKLER

Beyaz + Gri



Beyaz + Beyaz





- ✓ V2 Sınıfı Yanmaz, UV Dayanımlı, Antistatik Hammadde
- ✓ Ms64 Prinç Malzemeden Kontaklar
- ✓ 3x1 mm Gerçek Kesitli ve Tam Metrajında TSE'li Fişli Kablo
- ✓ Gövdede Askı Aparatı
- ✓ Montaj Kolaylığı Sağlayan Klemens Kapağı
- ✓ 3'lü, 4'lü ve 6'lü Seçenekleri ile Topraksız, Topraklı, Anahtarlı, Çocuk Korumalı, UPS'li Seçenekleri ile En Geniş Ürün Yelpazesi

Çocuk Koruma



Işıklı Anahtar



Asabilme Özelliği









Montaj Kolaylığı



origin

3'lü Grup Prizler

3'LÜ GRUP PRİZ	KOD	ÜRÜN ADI	FİYAT (TL)	KOLİ ADET
	150-010000-300	Orion Üçlü Grup Priz Klemensli	168,00	48
	150-010003-302	Orion Üçlü Grup Priz 2 M (2*0,75)	336,00	20
	150-010003-303	Orion Üçlü Grup Priz 3 M (2*0,75)	384,00	20
	150-010003-305	Orion Üçlü Grup Priz 5 M (2*0,75)	492,00	12
3'LÜ TOPRAKLI	KOD	ÜRÜN ADI	FİYAT (TL)	KOLİ ADET
	150-010000-310	Orion Üçlü Topraklı Grup Priz Klemensli	210,00	38
	150-010001-312	Orion Üçlü Topraklı Grup Priz 2 M (3*1)	480,00	14
	150-010001-313	Orion Üçlü Topraklı Grup Priz 3 M (3*1)	564,00	12
	150-010001-315	Orion Üçlü Topraklı Grup Priz 5 M (3*1)	720,00	12
3'LÜ ANAHTARLI TOPRAKLI	KOD	ÜRÜN ADI	FİYAT (TL)	KOLİ ADET
	150-011000-310	Orion Üçlü Anahtarlı Topraklı Grup Priz Klemensli	273,00	38
	150-011001-312	Orion Üçlü Anahtarlı Topraklı Grup Priz 2 M (3*1)	564,00	14
	150-011001-313	Orion Üçlü Anahtarlı Topraklı Grup Priz 3 M (3*1)	648,00	12
	150-011001-315	Orion Üçlü Anahtarlı Topraklı Grup Priz 5 M (3*1)	804,00	12
3'LÜ TOPRAKLI ÇOC. KORUMALI	KOD	ÜRÜN ADI	FİYAT (TL)	KOLİ ADET
	150-010010-310	Orion Üçlü Topraklı Grup Priz Çocuk Korumalı Klemensli	220,00	38
	150-010011-312	Orion Üçlü Topraklı Grup Priz Çocuk Korumalı 2 M (3*1)	492,00	14
	150-010011-313	Orion Üçlü Topraklı Grup Priz Çocuk Korumalı 3 M (3*1)	576,00	12
	150-010011-315	Orion Üçlü Topraklı Grup Priz Çocuk Korumalı 5 M (3*1)	744,00	12
3'LÜ ANAHTARLI TOPRAKLI ÇOC. KOR.	KOD	ÜRÜN ADI	FİYAT (TL)	KOLİ ADET
	150-011010-310	Orion Üçlü Anahtarlı Topraklı Grup Priz Çocuk Kor. Klemensli	283,50	38
	150-011011-312	Orion Üçlü Anahtarlı Topraklı Grup Priz Çocuk Kor. 2 M (3*1)	576,00	14
	150-011011-313	Orion Üçlü Anahtarlı Topraklı Grup Priz Çocuk Kor. 3 M (3*1)	660,00	12
	150-011011-315	Orion Üçlü Anahtarlı Topraklı Grup Priz Çocuk Kor. 5 M (3*1)	816,00	12
3'LÜ UPS GRUP PRİZ	KOD	ÜRÜN ADI	FİYAT (TL)	KOLİ ADET
	150-010000-320	Orion Üçlü UPS Klemensli	231,00	38
	150-010001-322	Orion Üçlü UPS 2 M (3*1)	504,00	14
	150-010001-323	Orion Üçlü UPS 3 M (3*1)	588,00	12
	150-010001-325	Orion Üçlü UPS 5 M (3*1)	744,00	12
3'LÜ UPS ANAHTARLI GRUP PRİZ	KOD	ÜRÜN ADI	FİYAT (TL)	KOLİ ADET
	150-011000-320	Orion Üçlü Anahtarlı UPS Klemensli	283,50	38
	150-011001-322	Orion Üçlü Anahtarlı UPS 2 M (3*1)	576,00	14
	150-011001-323	Orion Üçlü Anahtarlı UPS 3 M (3*1)	660,00	12
	150-011001-325	Orion Üçlü Anahtarlı UPS 5 M (3*1)	816,00	12

4'lü Grup Prizler

4'LÜ GRUP PRİZ	KOD	ÜRÜN ADI	FİYAT (TL)	KOLİ ADET
	150-010000-400	Orion Dörtlü Grup Priz Klemensli	189,00	42
	150-010003-402	Orion Dörtlü Grup Priz 2 M (2*0,75)	372,00	20
	150-010003-403	Orion Dörtlü Grup Priz 3 M (2*0,75)	420,00	20
	150-010003-405	Orion Dörtlü Grup Priz 5 M (2*0,75)	516,00	12

4'LÜ TOPRAKLI	KOD	ÜRÜN ADI	FİYAT (TL)	KOLİ ADET
	150-010000-410	Orion Dörtlü Topraklı Grup Priz Klemensli	241,50	30
	150-010001-412	Orion Dörtlü Topraklı Grup Priz 2 M (3*1)	528,00	12
	150-010001-413	Orion Dörtlü Topraklı Grup Priz 3 M (3*1)	612,00	12
	150-010001-415	Orion Dörtlü Topraklı Grup Priz 5 M (3*1)	768,00	12

4'LÜ ANAHTARLI TOPRAKLI	KOD	ÜRÜN ADI	FİYAT (TL)	KOLİ ADET
	150-011000-410	Orion Dörtlü Anahtarlı Topraklı Grup Priz Klemensli	315,00	30
	150-011001-412	Orion Dörtlü Anahtarlı Topraklı Grup Priz 2 M (3*1)	600,00	12
	150-011001-413	Orion Dörtlü Anahtarlı Topraklı Grup Priz 3 M (3*1)	684,00	12
	150-011001-415	Orion Dörtlü Anahtarlı Topraklı Grup Priz 5 M (3*1)	852,00	12

4'LÜ TOPRAKLI ÇOC. KORUMALI	KOD	ÜRÜN ADI	FİYAT (TL)	KOLİ ADET
	150-010010-410	Orion Dörtlü Topraklı Grup Priz Çocuk Korumalı Klemensli	252,00	30
	150-010011-412	Orion Dörtlü Topraklı Grup Priz Çocuk Korumalı 2 M (3*1)	612,00	12
	150-010011-413	Orion Dörtlü Topraklı Grup Priz Çocuk Korumalı 3 M (3*1)	624,00	12
	150-010011-415	Orion Dörtlü Topraklı Grup Priz Çocuk Korumalı 5 M (3*1)	780,00	12

4'LÜ ANAHTARLI TOPRAKLI ÇOC. KOR.	KOD	ÜRÜN ADI	FİYAT (TL)	KOLİ ADET
	150-011010-410	Orion Dörtlü Anahtarlı Topraklı Grup Priz Çocuk Kor. Klemensli	325,50	30
	150-011011-412	Orion Dörtlü Anahtarlı Topraklı Grup Priz Çocuk Kor. 2 M (3*1)	612,00	12
	150-011011-413	Orion Dörtlü Anahtarlı Topraklı Grup Priz Çocuk Kor. 3 M (3*1)	696,00	12
	150-011011-415	Orion Dörtlü Anahtarlı Topraklı Grup Priz Çocuk Kor. 5 M (3*1)	864,00	12

4'LÜ UPS GRUP PRİZ	KOD	ÜRÜN ADI	FİYAT (TL)	KOLİ ADET
	150-010000-420	Orion Dörtlü UPS Klemensli	262,50	30
	150-010001-422	Orion Dörtlü UPS 2 M (3*1)	552,00	12
	150-010001-423	Orion Dörtlü UPS 3 M (3*1)	636,00	12
	150-010001-425	Orion Dörtlü UPS 5 M (3*1)	792,00	12

4'LÜ UPS ANAHTARLI GRUP PRİZ	KOD	ÜRÜN ADI	FİYAT (TL)	KOLİ ADET
	150-011000-420	Orion Dörtlü Anahtarlı UPS Klemensli	325,50	30
	150-011001-422	Orion Dörtlü Anahtarlı UPS 2 M (3*1)	600,00	12
	150-011001-423	Orion Dörtlü Anahtarlı UPS 3 M (3*1)	684,00	12
	150-011001-425	Orion Dörtlü Anahtarlı UPS 5 M (3*1)	852,00	12

6'lı Grup Prizler

6'LI TOPRAKLI	KOD	ÜRÜN ADI	FİYAT (TL)	KOLİ ADET
	150-010000-610	Orion Altılı Topraklı Grup Priz Klemensli	304,50	25
	150-010001-612	Orion Altılı Topraklı Grup Priz 2 M (3*1)	600,00	12
	150-010001-613	Orion Altılı Topraklı Grup Priz 3 M (3*1)	672,00	10
	150-010001-615	Orion Altılı Topraklı Grup Priz 5 M (3*1)	864,00	8

6'LI ANAHTARLI TOPRAKLI	KOD	ÜRÜN ADI	FİYAT (TL)	KOLİ ADET
	150-011000-610	Orion Altılı Anahtarlı Topraklı Grup Priz Klemensli	378,00	25
	150-011001-612	Orion Altılı Anahtarlı Topraklı Grup Priz 2 M (3*1)	672,00	12
	150-011001-613	Orion Altılı Anahtarlı Topraklı Grup Priz 3 M (3*1)	756,00	10
	150-011001-615	Orion Altılı Anahtarlı Topraklı Grup Priz 5 M (3*1)	936,00	8

6'LI TOPRAKLI ÇOC. KORUMALI	KOD	ÜRÜN ADI	FİYAT (TL)	KOLİ ADET
	150-010010-610	Orion Altılı Topraklı Grup Priz Çocuk Korumalı Klemensli	315,00	25
	150-010011-612	Orion Altılı Topraklı Grup Priz Çocuk Korumalı 2 M (3*1)	612,00	12
	150-010011-613	Orion Altılı Topraklı Grup Priz Çocuk Korumalı Priz 3 M (3*1)	696,00	10
	150-010011-615	Orion Altılı Topraklı Grup Priz Çocuk Korumalı 5 M (3*1)	876,00	8

6'LI ANAHTARLI TOPRAKLI ÇOC. KOR.	KOD	ÜRÜN ADI	FİYAT (TL)	KOLİ ADET
	150-011010-610	Orion Altılı Anahtarlı Topraklı Grup Priz Çocuk Kor. Klemensli	388,50	25
	150-011011-612	Orion Altılı Anahtarlı Topraklı Grup Priz Çocuk Kor. 2 M (3*1)	684,00	12
	150-011011-613	Orion Altılı Anahtarlı Topraklı Grup Priz Çocuk Kor. 3 M (3*1)	768,00	10
	150-011011-615	Orion Altılı Anahtarlı Topraklı Grup Priz Çocuk Kor. 5 M (3*1)	948,00	8



Çocuk korumalı seçeneği ile evde, ofiste, atölyede ve şantiyede güvenlik sağlıyor. Farklı uzunluklardaki kablo boyları ile daha rahat çalışma alanı sağlarken, asılabilme özelliği sayesinde daha rahat kullanım imkanı veriyor.



170-010002-708
Kulplu Topraklı Erkek Fiş



170-010002-707
Topraklı Erkek Fiş L Tipi



170-010102-705
Elastik Topraklı Erkek Fiş



170-010002-703
Topraklı Erkek Fiş



170-010102-706
Elastik Topraklı Dişi Fiş



170-010002-701
Topraksız Erkek Fiş



170-010001-700
Arapuar



170-010002-704
Topraklı Dişi Fiş



170-010002-702
Topraksız Dişi Fiş



170-010002-006
Mobilya Prizi

KOD	ÜRÜN ADI	FİYAT (TL)	KOLİ ADET
170-010001-700	Arapuar Anahtar (Beyaz-Kırmızı)	43,20	450
170-010002-701	Topraksız Erkek Fiş	48,00	300
170-010002-702	Topraksız Dişi Fiş	43,20	175
170-010002-703	Topraklı Erkek Fiş	62,40	200
170-010002-704	Topraklı Dişi Fiş	72,00	100
170-010002-707	L Tipi Topraklı Erkek Fiş	64,80	175
170-010102-705	Elastik Topraklı Erkek Fiş	74,40	100
170-010102-706	Elastik Topraklı Dişi Fiş	84,00	80
170-010002-006	Mobilya Prizi	120,00	100
170-010002-708	Kulplu Topraklı Fiş	69,60	175

OTOMAT KUTULARI

SIVA ALTI | SIVA ÜSTÜ

Yaylı
Kapak
Mekanizması



Kırılmaz
Polycarbonate
Malzeme

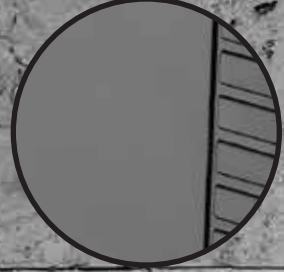

Sıva Altı Otomat Kutuları



GÖRSEL	KOD	ÜRÜN ADI	FİYAT (TL)	KOLİ ADET
	180-010001-006	6'lı Sıva Altı Sigorta Kutusu - Klemensli	411,60	24
	180-010001-008	8'li Sıva Altı Sigorta Kutusu - Klemensli	450,80	24
	180-010001-012	12'li Sıva Altı Sigorta Kutusu - Klemensli	548,80	16
	180-010001-016	16'lı Sıva Altı Sigorta Kutusu - Klemensli	666,40	12
	180-010001-024	24'lü Sıva Altı Sigorta Kutusu - Klemensli	882,00	8
	180-010001-036	36'lı Sıva Altı Sigorta Kutusu - Klemensli	1.215,20	6

Sıva Üstü Otomat Kutuları



GÖRSEL	KOD	ÜRÜN ADI	FİYAT (TL)	KOLİ ADET
	180-010002-006	6'lı Sıva Üstü Sigorta Kutusu - Klemensli	450,80	24
	180-010002-008	8'li Sıva Üstü Sigorta Kutusu - Klemensli	529,20	24
	180-010002-012	12'li Sıva Üstü Sigorta Kutusu - Klemensli	627,20	16
	180-010002-016	16'lı Sıva Üstü Sigorta Kutusu - Klemensli	784,00	12
	180-010002-024	24'lü Sıva Üstü Sigorta Kutusu - Klemensli	980,00	8
	180-010002-036	36'lı Sıva Üstü Sigorta Kutusu - Klemensli	1.332,80	6

Sıva Üstü Mühürlü Sigorta Kutuları



GÖRSEL	KOD	ÜRÜN ADI	FİYAT (TL)	KOLİ ADET
	180-010002-102	1-2'li Sıva Üstü Sigorta Kutusu - Mühürlü (Poşetli)	66,64	70
	180-010002-104	3-4'lü Sıva Üstü Sigorta Kutusu - Mühürlü (Poşetli)	90,16	42

- Yaylı mekanizma sayesinde kolayca açılıp kapanma özelliği.
- Kırılmaz Polycarbonate füme kapak.
- 180° açılabilen kapağı ile montaj kolaylığı.
- Kapak montaj yer durumuna göre sağa ya da sola açılacak şekilde konumlandırılabilir.
- EN 60715 standardına uygun olarak sigorta bağlantı rayı galvaniz sac malzemeden üretilmiştir.
- Topraklama bağlantı klemensi mevcuttur.
- Halogen Free özelliği.
- 650 °C'ye kadar aleve ve yanmaya dayanıklılık.
- IP40 koruma seviyesi.
- CE standartlarına uygunluk.
- Ürün montajı için gerekli tüm malzemeler kutu içerisindedir.



MONO[®]
LIGHTING

LED light



Daha Güzel
Bir Dünya İçin
Çevre Dostu
Ürünler

www.monoaydinlatma.com.tr





www.monoelectric.com.tr

Akpınar Sanayi Bölgesi - Yassıören Mah. Hadımköy Cad.
No:162 Arnavutköy / İSTANBUL - TURKEY

T: +90 (212) 549 84 78 - 549 84 79 - 549 84 81

F: +90 (212) 549 84 04

E: info@monoelectric.com.tr | export@monoelectric.com.tr

 /MonoElectricOfficial

 @MonoElectricTr

 @monoelectricofficial